

LEISTER®

English

UNIDRIVE 500



Leister Technologies AG
Galileo-Strasse 10
CH-6056 Kaegiswil, Switzerland
Tel. +41 41 662 74 74
Fax +41 41 662 74 16
www.leister.com
sales@leister.com

Contents

1. Application	3
1.1 Intended use	3
1.2 Improper use	3
2. Technical data	3
3. Transport	4
4. Your UNIDRIVE 500	5
4.1 Type plate and identification	5
4.2 Scope of delivery	5
4.3 Overview of device parts	6
5. Settings on the UNIDRIVE 500	7
5.1 Adjusting the Welding Nozzle	7
5.2 Retooling for different welding widths	8
6. Commissioning your UNIDRIVE 500	9
6.1 Work environment and safety	9
6.2 Operating readiness	10
6.3 Positioning the device	10
6.4 Starting the device	11
6.5 Welding sequence	12
6.6 Switching off the device / Maintenance	12
7. Quick Guide UNIDRIVE 500	13
7.1 Switching on/Starting	13
7.2 Switching off	13
8. Operating unit UNIDRIVE 500	13
8.1 Function keys	13
8.2 Display	14
8.3 Display symbols of the status display (Display 20)	15
8.4 Display symbols for the welding speed (Display 21)	15
8.5 Display symbols for the welding temperature (Display 22)	15
8.6 Display symbols for the air volume (Display 23)	15
8.7 Status LED display	15
9. Settings and functions of the UNIDRIVE 500 software	16
9.1 Setting the parameter units	16
9.2 Setting the welding parameters	16
9.3 Cool down mode	17
9.4 Monitoring welding parameters during runtime	17
9.5 Switch drive direction	17
10. Warning and error messages UNIDRIVE 500	18
11. FAQ, causes and measures UNIDRIVE 500	19
12. Declaration of Conformity	20

Congratulations on your purchase of the UNIDRIVE 500.

You have chosen a first-class semi-automatic hot-air welder.

It was developed and produced in accordance with the latest state-of-the-art technology in the plastics-processing industry.

It has also been manufactured using high-quality materials.



We recommend that you always keep the operating instructions with the device.

UNIDRIVE 500

Industrial hot-air tool



For further information on the UNIDRIVE 500, visit www.leister.com

1. Application

1.1 Intended use

The UNIDRIVE 500 is intended for professional use on flat and sloping roofs, certain geosynthetic applications, and the swimming pool market.

Welding processes and types of materials

- Overlap welding of thermoplastic/elastomer membranes (such as TPO/FPO, PVC, ECB, modified EPDM, EVA, PIB, PMI, PO, PP)
- Overlap welding for base seams
- Close-edge welding on roof and cross-seam parapets and eaves up to 60 mm
- Welding on roof parapets and eaves
- Welding widths: 15, 30 and 40 mm
- Swimming pool models
- Waterstops for below-grade concrete applications
- Circumferential welds

1.2 Improper use

Any other use of the UNIDRIVE 500 or any use beyond the type of use described is deemed improper use.

2. Technical data

		UNIDRIVE 500 100 V	UNIDRIVE 500 100 - 120 V	UNIDRIVE 500 220 – 240 V
	V~	100	120	230
	Hz	50 / 60	50 / 60	50 / 60
	W	1500	1800	2200
	°C		100 – 560	
	°F		220 – 1040	
	%		45 – 100	
	m/min		0,7 - 4,5	
	ft/min		2.3 – 14.8	
	L _{PA} (dB)		70 (K = 3 dB)	
	m/s ²		< 2.5 (K = 1.5)	
	ft/s ²		< 8.2 (K = 4.9)	
	kg		4.5	
	lbs		9.9	
	a) mm / inch		297 / 11.7	
	b) mm / inch		173 / 6.8	
	c) mm / inch		275 / 10.8	

We reserve the right to make technical changes at any time without prior notice.

3. Transport



Comply with applicable national statutes regarding the carrying or lifting of loads. The weight of your UNIDRIVE 500 including the transport box is 7.5 kg (4.5 kg without transport box).

Transport the semi-automatic hot air welder only with the transport box included with the delivery (see  scope of delivery 5 [4.2]) and carry the transport box by the handle provided.



The **hot-air blowers (6)** MUST be allowed to cool down prior to transport.



Never store flammable materials (such as plastic, wood, or paper) in the transport box.



Never use the **carrying handle (4)** on the device or on the transport box for transporting with a crane.



To manually raise the semi-automatic hot air welder, use the **carrying handle (4)**.

4. Your UNIDRIVE 500

4.1 Type plate and identification

The model and serial number are indicated on your device's **type plate (12)**.

Please enter this information in your operating instructions and always reference it when addressing queries to our representatives or authorized Leister Service Centers.

Model:.....

Serial no.:.....

Example:



4.2 Scope of delivery

Standard equipment in the case:

- 1 x UNIDRIVE 500 drive
- 1 x wire brush
- 1 x hexagon wrench key, size 3
- 1 x quick guide
- 1 x safety instructions

4.2 Overview of device parts

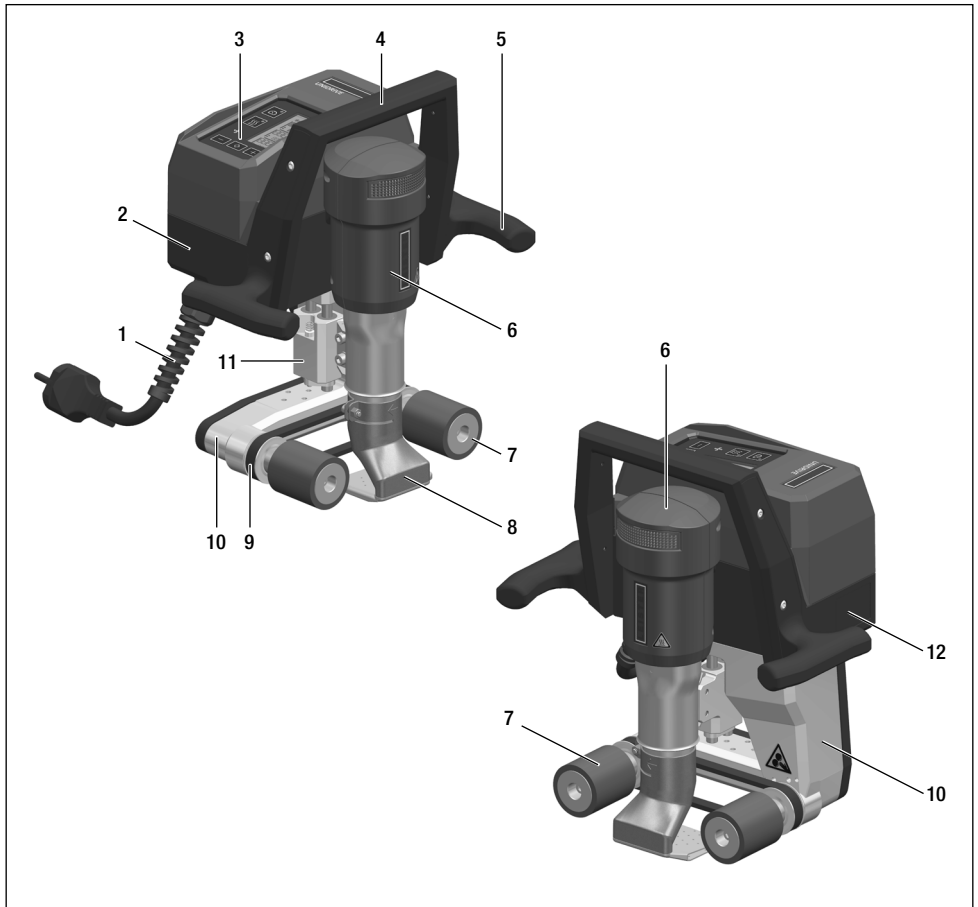

1. Power cord
2. Housing
3. Operating unit
4. Carrying handle, top
5. Handle, side
6. Hot-air blower
7. Drive/pressure roller
8. Welding nozzle 15-40 mm
9. Drive and pressure belt
10. Undercarriage
11. Height adjustment
12. Type plate with model designation and series marking

5. Settings on the UNIDRIVE 500

5.1 Adjusting the Welding Nozzle

Set welding direction and angle

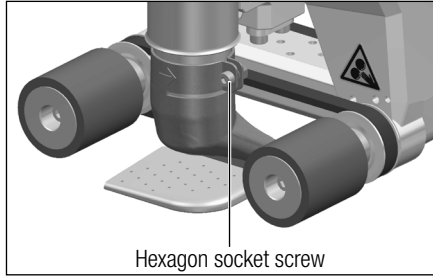
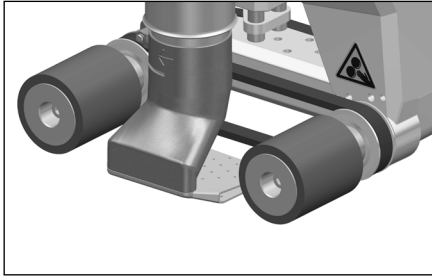

The direction of the arrow on the **welding nozzle (8)** defines the welding direction.

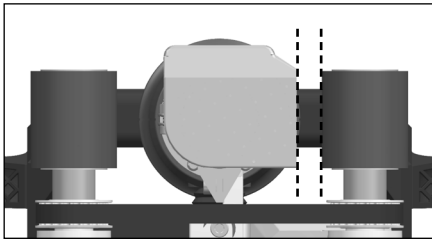

Align the welding nozzle (8) parallel to the drive/pressure roller (7).

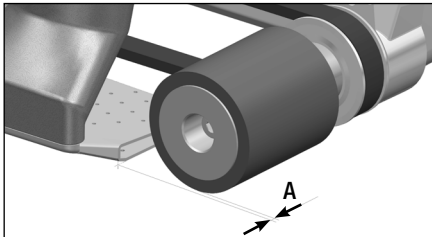

A = 1 – 2 mm

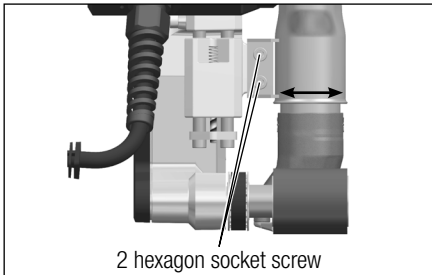
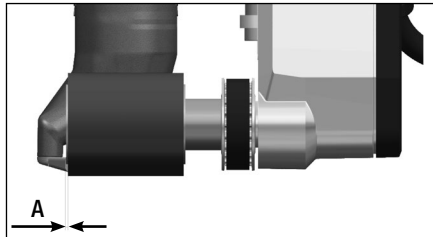

Set distance **A** (2 hexagon socket screws)

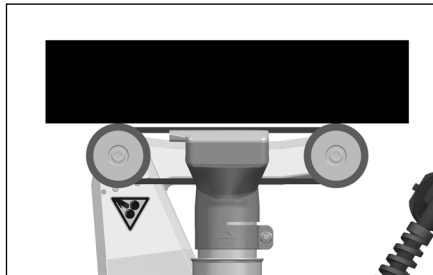

5.2 Retooling for different welding widths

To retool to a different welding width, proceed in accordance with the sequence described below.

Step 1: Safety precautions



Allow the device to cool down in Cool Down mode.

Before beginning with dismantling work, make sure that the **power cord (1)** is disconnected from the mains.

Step 2: Adjusting the roller width (analogous to the 15, 30, or 40 mm welding nozzle)

1. Release the cheese head screws M5 on the two **drive/pressure rollers (7)** (screw length varies depending on roller type).
2. Remove the **drive/pressure rollers (7)**.
3. Mount the new **drive/pressure rollers (7)**.
4. Retighten the new M5 cheese head screws.

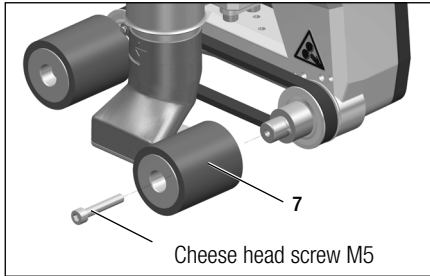

Step 3: Changing the welding nozzle (15, 30 or 40 mm)

5. Release the hexagon socket screw.
6. Remove the **welding nozzle (8)** that is currently mounted.
7. Insert the desired **welding nozzle (8)**.
8. Adjust the **welding nozzle (8)** (see  Adjust welding nozzles 7 [5.1]).
9. Retighten the hexagon socket screw.

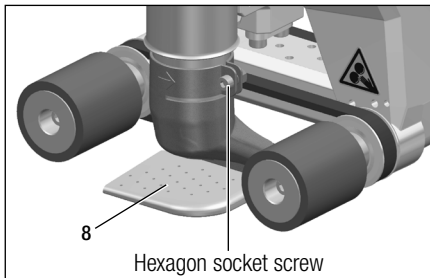

6. Commissioning your UNIDRIVE 500

6.1 Work environment and safety

Step 1: Safety precautions

The semi-automatic hot-air welder must only be used in the open or in a well-ventilated area.



Never use the semi-automatic hot-air welder in explosive or readily inflammable surroundings and maintain sufficient distance from combustible materials or explosive gases at all times.

Read the material safety data sheet of the manufacturer of the material and follow that company's instructions. Be careful not to burn the material during the welding process.

Use the device only on a fireproof surface.



In addition, comply with national statutory requirements regarding occupational safety (securing personnel or devices).



Anti-fall protection when working on areas where there is a danger of falling.

When welding on roof parapet (parapet, eaves), the semi-automatic hot-air welder must be secured to an anchor point using the carrying handle (4) and a safety line (e.g. rail or rope safety systems) as protection against falling.

With respect to the safety chain, care must be taken to ensure that all of the safety elements (carabiner hooks, ropes) have a minimum load-carrying capacity of 7 kN in every anticipatable direction. For the suspension of the machine, it is mandatory to use clasp carabiners (Twist-Lock or screw types). All safety chain connections must be installed and checked in accordance with manufacturer specifications.

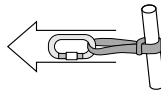

Before each use and after any unusual occurrences, the **carrying handle (4)** that is used for fastening the safety rope must be inspected by an individual with expertise in this area. **The carrying handle (4)** is not permitted to exhibit any cracks, corrosion, notches or other material faults.

Caution: Secure the semi-automatic hot air welder with the **carrying handle (4)** only!

Caution: The semi-automatic hot-air welder must never be fastened to single anchoring points which allow ropes to sag. The connection equipment must always be set to the shortest length possible in order to eliminate the chance of falling over the edge of the parapet.

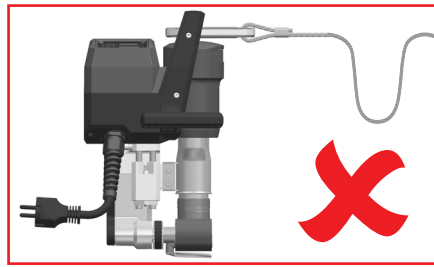
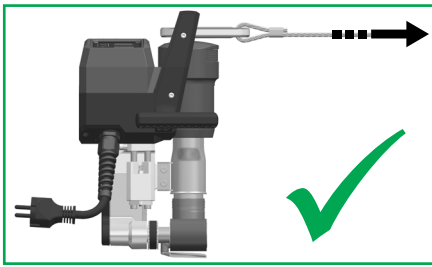

Caution: The device may fall or drop in an uncontrolled manner due to gravity. The securing point is not designed to withstand the shock-like stress of an abrupt fall.

Contact the manufacturer without hesitation if uncertainties arise during installation or operation.

Power cord and extension cable

- The nominal voltage specified on the device (see  Technical data 3 [2]) must match the mains voltage.
- The **power cord (1)** must be able to move freely and must not hinder the user or third parties during work (danger of tripping).
- The extension cable must be authorized for outdoor use and be marked accordingly. Take into account the necessary minimum cross-section/gauge for extension cables, as required.

Generators for power supply

When using generators as a power supply, please ensure that the generators are grounded and equipped with residual-current circuit breakers.

When selecting the nominal output of the generators, the formula $\langle 1.5 - 2 \times \text{nominal output of the semi-automatic hot-air welder} \rangle$ applies.

6.2 Operating readiness

Check the basic setting of the **welding nozzle (8)**.

6.3 Positioning the device

- Check whether the material to be welded is clean between the overlap and on the upper and lower sides.
- Then check whether the **welding nozzle (8)**, the **drive/pressure roller (7)**, and the **pressure belt (9)** are clean.
- If necessary, position the optionally available welding plate (see  Scope of delivery 5 [4.2]).

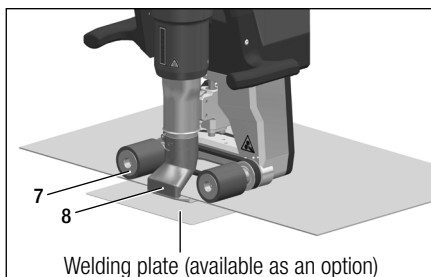

Tool resting position

- Place the semi-automatic hot-air welder on a horizontal and fireproof surface.
- The semi-automatic hot-air welder is placed on its back for the resting position (heating, cool down mode).

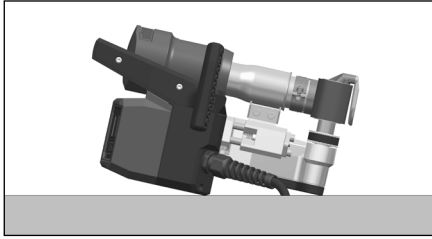

6.4 Starting the device

- Once you have prepared the working area and the semi-automatic hot-air welder in accordance with the description, connect the device to the mains voltage.

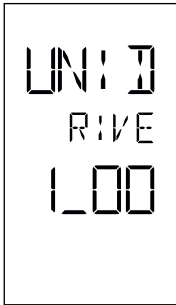

After connection, the **start screen** appears briefly on the display of the **operating unit (3)** with the version number of the current software release and the device designation.

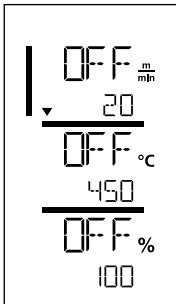

If the device was allowed to cool down beforehand, this will be followed by a static display of the setpoints for the most recently set welding parameters.

At this stage, the heating, blower and drive are switched off.

- Now switch on the heating ("**Heating on/off**" key, 16).

6.5 Welding sequence

Preparing for welding

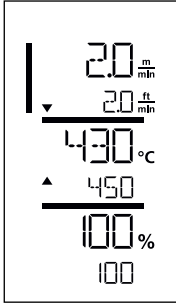

As soon as you have switched on the heating, you will see a **dynamic display of the current air temperature** (setpoint and actual value). All welding parameters (welding speed, temperature and air volume) can be set.

- The drive motor starts automatically as soon as the heating is activated.
- Check whether the correct drive direction (left or right) is set and compare it with the direction on the nozzle to match the arrow so that it matches the arrow on the display (see  Switch drive direction 17 [9.5]).
- Make sure that the welding temperature has been reached before commencing work (the heating-up time is –three to five minutes).
- Now carry out test welds in accordance with the welding instructions of the material manufacturer and/or national standards or regulations and inspect the results. Adjust the welding profile as needed.



Do not touch moving parts

There is a risk of inadvertently becoming caught and being pulled in. Do not wear articles of clothing such as scarves or shawls. Tie up long hair or protect it by wearing headgear.

Commencing welding

- Insert the **welding nozzle (8)** between the overlapped sheets.

During the welding process

- Guide the semi-automatic hot-air welder by the **handles on the side (5)** or by the **carrying handle (4)** along the overlap and also observe the position of the **drive / pressure rollers (7)**.
- The welding speed, air volume, and air temperature can be adjusted at any time during welding (see  Setting welding parameters 16 [9.2]).

Finishing welding

- After the welding, move the semi-automatic hot-air welder out of the overlapping sheets.

6.6 Switching off the device / Maintenance

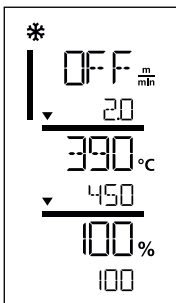

Switch off the heating with the **Heating on/off key (16)**.

- The device switches to cool down mode.
- The blower switches off automatically after approx. six minutes.
- Then disconnect the **power cord (1)** from the mains.



- Wait until the device has cooled down.
- Check the **power cord (1)** and plug for electrical and/or mechanical damage.
- Clean the **welding nozzle (8)** with a wire brush (available as an option).

7. Quick Guide UNIDRIVE 500

7.1 Switching on/Starting

1. Connect the mains voltage plug
2. Set the welding parameters
3. Switch on the heating with the **Heating On/Off key (16)**; wait three to five minutes until the desired temperature is reached
4. If necessary, **adjust the direction of rotation of the drive (15 + 17)**
5. Slide the **welding nozzle (8)** into the overlap

7.2 Switching off

1. Remove the semi-automatic hot-air welder
2. Switch off the heating using the **Heating on/off key (16)**
3. Wait for end of cool-down process (approx. six minutes)
4. Pull out mains voltage plug

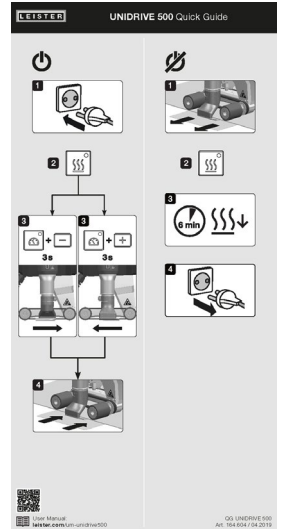



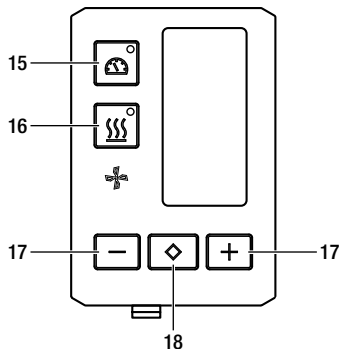

8. Operating unit UNIDRIVE 500

The **operating unit (3)** consists of the **function keys** with which you can activate and/or deactivate the drive or heating, the Confirm key for selecting the setpoints to be configured, as well as the **display** on which the currently selected setting is displayed.

8.1 Function keys



- 15 "Drive on/off" key
- 16 "Heating on/off" key
- 17 Minus/Plus keys
- 18 "Confirm" key

Symbol	Designation	Function
	"Motor On/Off (15)	Switches drive on and off
	Heating key On/Off (16)	Switches heating on and off
	Blower symbol	No function
	Minus / Plus keys (17)	Setting the required setpoint in increments of 0.1 m/min, 10 °C or 5%
	"Confirm" key (18)	Switches between the setpoints to be set

8.2 Display



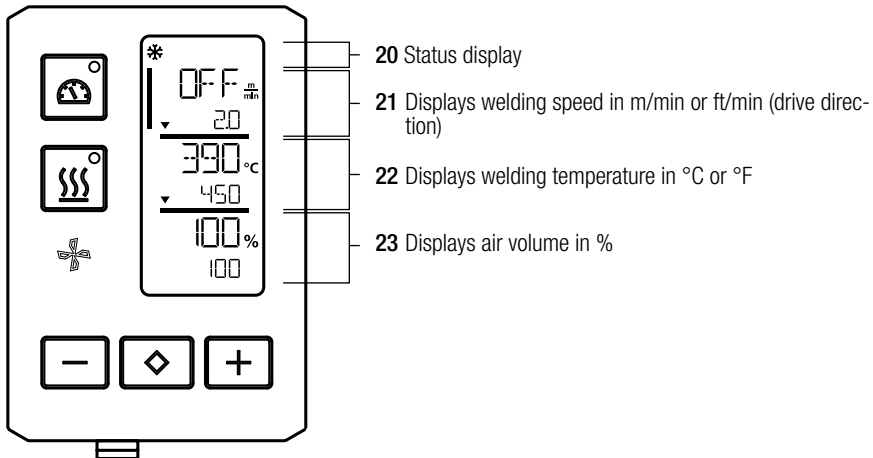

The display is subdivided into four areas:



During operation, the setpoints of the welding parameters (drive in m/min or ft/min, temperature in degrees Celsius or Fahrenheit), air volume in percent and, if applicable, information notes are displayed.

You can use the **"Confirm" key (18)** to switch between the welding parameters. Use the **Minus/Plus arrow keys (17)** to adjust the values individually.

8.3 Display symbols of the status display (Display 20)

Symbol	Meaning
	Symbol for cool down mode
	Symbol for warning note, warning message or error message causing the device to cool down. (see also  Warning and error messages 18 [10])
	Indicates service required. Symbol for hardware error message. The device is no longer ready for operation. Contact an authorized Leister Service Center. (Note the respective error code in Chapter  Warning and error messages 18 [10]).

8.4 Display symbols for the welding speed (Display 21)



Actual and setpoint value of the welding speed

The arrow in the display for the welding speed indicates the drive direction.

8.5 Display symbols for the welding temperature (Display 22)



Welding temperature too low, heat-up process.

Up arrow shows that the desired **higher temperature** has not yet been reached.

The flashing number designates the currently achieved actual value (430); the value below (450) shows the setpoint of the individual setting.



Welding temperature too high, cool-down process.

Down arrow shows that the desired **lower temperature** has not yet been reached.

The flashing value designates the currently achieved actual value (470); the value below (450) shows the setpoint of the individual setting.

8.6 Display symbols for the air volume (Display 23)



Actual and setpoint value of the air volume

8.7 Status LED display

Heating

The LED on the **Heating "On/Off" key (16)** displays the condition of the heating.

LED status Heating On/Off (16)	Condition
LED off	Heating is switched off.
LED flashes green	Heating is switched on. Temperature is outside the tolerance.
LED continuously green	Heating is switched on. Temperature is inside the tolerance.

Drive

The LED on the **Drive "On/Off" key (15)** displays the condition of the drive.

LED status Drive On/Off (15)	Condition
LED off	Drive is switched off
LED continuously green	Drive is switched on

Heating and drive

If the two LEDs for the **Heating «On/Off» (16) key** and the **Drive «On/Off» (15) key** flash simultaneously, an error is pending (see Chapter Error messages).

9. Settings and functions of the UNIDRIVE 500 software

9.1 Setting the parameter units

The units for the welding speed and for the temperature can be adjusted.

Temperature: °C or °F

Speed: $\frac{\text{m}}{\text{min}}$ or $\frac{\text{ft.}}{\text{min}}$

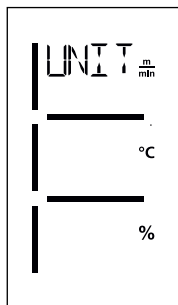

- Hold down the **Drive "On/Off" (15)** and **Heating "On/Off" (16)** keys and connect the power cord to the mains. "UNIT" then appears on the display.
- Press the **Confirm key (18)** to confirm and set the desired units using the **Plus/Minus keys (17)**.
- Press the **"Confirm" key (18)** to confirm and use the **Minus/Plus keys (17)** to select "SAVE". Press the **Confirm key (18)** to confirm; the units are then saved.

The device then restarts automatically.

9.2 Setting the welding parameters

You can regulate the setpoints of the three welding parameters individually, even during operation.

During operation, the selected range switches automatically after 5 seconds back to the **welding speed (21)** row.

Proceed as follows:

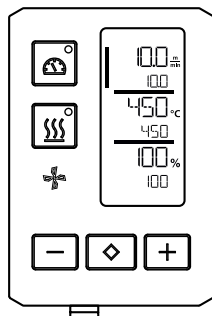

Select:

Select the desired setpoint for drive, temperature or air with the **"Confirm" key (18)**.

Presentation:

The selected range is indicated by a bar on the left side of the LED display.

Settings:

Use the **Minus/Plus keys (17)** to adjust the selected setpoint to match your requirements.

9.2 Cool down mode

The heating is switched off during the cool-down process. The setpoints cannot be changed during the cool-down process.

If the air temperature is more than 100°C when the device is switched on, the device switches automatically to cool down mode.

The cool-down process is finished when the air temperature is less than 100°C for two minutes.

If the heating is to be switched back on, press the relevant **key (16)**.

9.3 Monitoring welding parameters during runtime

Welding speed, air temperature and air volume are monitored on an ongoing basis with the closed-loop technology.

If an actual value deviates from the setpoint according to the individual settings, this is indicated in the working display (see  Display symbols for the welding temperature 15 [8.5]).

9.4 Switch drive direction

Hold down the **Drive "On/Off" key (15)** and the **Minus or Plus key (17)** for three seconds.

- Minus key clockwise
- Plus key counterclockwise

The direction of the arrow changes in the **Welding speed display (21)**.

See  Quick Guide UNIDRIVE 500 13 [7]

10. Warning and error messages UNIDRIVE 500

Error messages are shown on the display of the operating unit (3)

If an error message appears, you cannot continue working.

The heating is switched off automatically and the drive is blocked. The corresponding error codes are displayed immediately on the **display of the operating unit (3)**. The first four digits indicate the error group. The second four digits indicate the detailed error. Contact an authorized Leister Service Center.

Example:

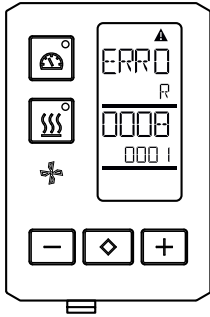

Error group	Description	Measures
0001	Electronics temperature measurement	Temperature > 90 °C. Allow the device to cool down
0004	Supply voltage	Connect the device to a different power socket. If the error is still displayed, contact the Leister Service Center.
0008	Thermocouple/heating element	Contact Leister Service Center
0100	Blower motor	Contact Leister Service Center
0400	Drive motor	Contact Leister Service Center

11. FAQ, causes and measures UNIDRIVE 500

The machine switches on automatically after the blowers have been switched on:

- If the air temperature is more than 100°C when the device is switched on, the device switches automatically to cool down mode. The cool-down process is finished when the air temperature is less than 100 °C for two minutes.

Deficient welding result quality:

- Check drive speed, welding temperature and air volume. Check the material manufacturer's installation instructions
- Clean **welding nozzle (8)** with wire brush.
- **Welding nozzle (8)** incorrectly adjusted (see Adjust welding nozzles).
- Incorrect drive direction
- Pressure not sufficient and incorrectly applied

After five minutes at the most, the set welding temperature has still not been reached:

- Inspect supply voltage.
- Reduce air volume.

12. Declaration of Conformity

EC declaration of conformity

(in terms of the EC machinery directive 2006/42/EC; Appendix II A)

Leister Technologies AG

Galileo-Strasse 10, CH-6056 Kaegiswil/Switzerland

hereby declares the machine described below, released by us, fulfills the provisions of the following EC directive(s):

Designation	Hot Air Welder
Type	Unidrive 500
EC directive(s)	2006/42/EC (Machinery Directive) 2014/30/EU (EMC Directive) 2014/35/EU (Low Voltage Directive) 2011/65/EU (RoHS Directive)
Harmonised standards	EN ISO12100: 2010 EN 55014-1:2006 + A1:2009 + A2:2011 EN 55014-2:2015 EN 61000-3-2: 2014 EN 61000-3-3: 2013 EN 62233: 2008 EN 60335-1: 2012 + A11: 2014 + A13:2017 EN 60335-2-45: 2002 + A1:2008+ A2: 2012 EN 50581:2012

Authorised documentation representative Thomas Schäfer, Manager Product Conformity

Kaegiswil, 15.04.2019

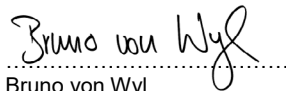

.....
Bruno von Wyl
(Chief Technical Officer)



.....
Christoph Baumgartner
(General Manager)

Warranty

- The guarantee or warranty rights granted for this device by the direct distribution partner/salesperson apply from the date of purchase. In the event of a guarantee or warranty claim (verification by invoice or delivery note), manufacturing or processing errors will be rectified by the sales partner through replacement delivery or repair. Heating elements are excluded from warranty obligations or guarantees.
- Other guarantee or warranty claims are excluded within the framework of mandatory law.
- Damage resulting from natural wear, overload, or improper handling is excluded from the warranty.
- No guarantee or warranty claims exist for devices that have been converted or modified by the purchaser.

↳ Sales and service center

Leister Technologies AG
Galileo-Strasse 10
CH-6056 Kaegiswil/Switzerland
Tel. +41 41 662 74 74
Fax +41 41 662 74 16
www.leister.com
sales@leister.com