

**LEISTER**®

English

# UNIROOF 700/300



Leister Technologies AG  
Galileo-Strasse 10  
CH-6056 Kaegiswil/Switzerland  
Tel. +41 41 662 74 74  
Fax +41 41 662 74 16  
[www.leister.com](http://www.leister.com)  
[sales@leister.com](mailto:sales@leister.com)

## Table of contents

<b>1</b>	<b>Important safety instructions</b>	<b>4</b>
1.1	Intended use	5
1.2	Non-intended use	5
<b>2</b>	<b>Technical data</b>	<b>6</b>
<b>3</b>	<b>Transport</b>	<b>7</b>
<b>4</b>	<b>Your UNIROOF 700/300</b>	<b>8</b>
4.1	Type plate and identification	8
4.2	Scope of delivery (standard equipment in the case)	8
4.3	Overview of device parts	9
<b>5</b>	<b>Settings on the UNIROOF 700/300</b>	<b>11</b>
5.1	Adjusting the welding nozzles	11
5.2	Additional weights for increasing the contact pressure weight	12
5.3	Adjusting the guide bar	12
5.4	How to adjust the movable transport axle (patent EP3 028 836 pending)	13
5.5	Retooling for different welding width	14
<b>6</b>	<b>Commissioning your UNIROOF 700/300</b>	<b>16</b>
6.1	Work environment and safety	16
6.2	Operating readiness	18
6.3	Positioning the device	19
<b>7</b>	<b>Operation of your UNIROOF 700</b>	<b>20</b>
7.1	Starting the device	20
7.2	Welding sequence	21
7.3	Finishing welding	21
7.4	Switching off the device / Maintenance	21
<b>8</b>	<b>Quick Reference Guide UNIROOF 700</b>	<b>22</b>
8.1	Switching on/Starting	22
8.2	Switching off	22
<b>9</b>	<b>Control panel of the UNIROOF 700</b>	<b>23</b>
9.1	Function buttons	23
9.2	Display	24
9.3	Setting the welding parameters	24
9.4	Display symbols of the status display (Display 40)	25
9.5	Display symbols of the work display (Display 41)	26
<b>10</b>	<b>Settings and functions of the UNIROOF 700 software</b>	<b>27</b>
10.1	Overview menu navigation UNIROOF 700	27
10.2	Basic settings and Advanced Mode	30
10.3	Recipes	30
10.4	Displaying target values (Set values)	32
10.5	Eco mode	33
10.6	Settings for LQS [Leister Quality System] data recording	33

10.7	Advanced mode settings	37
10.8	WLAN settings	40
10.9	Machine settings	41
10.10	Info mode	43
10.11	Duty info	43
10.12	General Info	44
<b>11</b>	<b>UNIROOF 700 Warning and error messages</b>	<b>44</b>
<b>12</b>	<b>FAQ, causes and actions UNIROOF 700</b>	<b>46</b>
<b>13</b>	<b>Operation of your UNIROOF 300</b>	<b>47</b>
13.1	Starting the device	47
13.2	Welding sequence	47
13.3	Finishing welding	48
13.4	Switching off the device / Maintenance	48
<b>14</b>	<b>Quick Reference Guide UNIROOF 300</b>	<b>49</b>
14.1	Switching on/Starting	49
14.2	Switching off	49
<b>15</b>	<b>The UNIROOF 300 operating unit</b>	<b>50</b>
15.1	Function buttons	50
15.2	Display	51
15.3	Display symbols of the status display (Display 34)	51
15.4	Display symbols for the welding speed (Display 35)	52
15.5	Display symbols for the welding temperature (Display 36)	52
15.6	Display symbols for the air volume (Display 37)	52
15.7	Status LED display	52
<b>16</b>	<b>Settings and functions of the UNIROOF 300 software</b>	<b>53</b>
16.1	Setting the parameter units	53
16.2	Setting the welding parameters	53
16.3	Cool-down mode	54
16.4	Monitoring welding parameters for runtime	54
<b>17</b>	<b>Warning and error messages UNIROOF 300</b>	<b>55</b>
<b>18</b>	<b>FAQ, causes and actions UNIROOF 300</b>	<b>56</b>
<b>19</b>	<b>Accessories</b>	<b>57</b>
<b>20</b>	<b>Service and repair</b>	<b>57</b>
<b>21</b>	<b>Training</b>	<b>57</b>
<b>22</b>	<b>Warranty</b>	<b>57</b>
<b>23</b>	<b>Declaration of Conformity</b>	<b>58</b>
<b>24</b>	<b>Disposal</b>	<b>58</b>

## Congratulations on your purchase of the UNIROOF 700/300.

You have chosen a first-class hot-air welder.

It was developed and produced in accordance with the latest state-of-the-art technology in the plastics-processing industry.

It has also been manufactured using high-quality materials.



We recommend that you always keep the instruction manual with the device.

# UNIROOF 700/300

## Hot-air welder



You can find more information on the UNIROOF 700/300 at [www.leister.com](http://www.leister.com)

### 1. Important safety instructions

#### Read through the operating instructions before commissioning for the first time.

In addition to the safety instructions contained in the individual sections of this instruction manual, the following regulations must always be observed.

#### Warning



##### Danger to life

Before opening the device, pull the power plug out of the socket, because voltage-bearing components and connections will be exposed when it is opened.



##### Danger of fire and explosion

Risk of fire and explosion caused by improper use of the automatic welding machine (such as material overheating), and particularly in the vicinity of flammable materials and explosive gases.



##### Risk of burning

Do not touch the heating element tube and nozzle when they are hot. The device should always first be allowed to cool down.

Never point the hot air flow at people or animals.

#### Caution



Connect the device to an outlet with a **protective conductor**. Any interruption of the protective conductor inside or outside of the device is dangerous.

Only use extension cables with protective conductors.



The local supply **voltage** must match the nominal **voltage** specified on the device. Maximum network impedance according to EN 61000-3-11 / UL 499 / CSA C22.2 No 88:  $Z_{max} = 0.141 \Omega + j 0.088 \Omega$ . In case of doubt, the responsible electricity supply company should be contacted.

If the line voltage fails, then the main switch and the drive must be switched off (extend hot-air blower).



If the device is being used on construction sites, a fault current circuit breaker **must be used to protect site personnel**.



**Do not touch moving parts.**

There is a risk of inadvertently becoming caught and being pulled in. Do not wear loose articles of clothing such as scarves or shawls. Tie up long hair or protect it by wearing headgear.



The device **may only be operated under supervision** as waste heat can reach flammable materials. The device should only be operated by **trained specialists** or under their supervision. Children are not permitted to operate the device.



Protect the device **from moisture and wet conditions**.



**Two persons are required** for transporting the machine with the transport box.

### 1.1 Intended use

UNIROOF 700/300 is intended for professional use on flat roofs and sloping roofs up to a 30-degree angle of inclination.

Only use original Leister spare parts and accessories; otherwise, any warranty or guarantee claims will be invalidated.









#### **Welding procedures and types of materials**







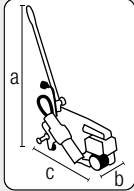

- Overlap welding of thermoplastic sealing sheets/elastomer sealing sheets (such as TPO, PVC, ECB, modified EPDM, EVA, FPO, PIB, PMI, PO, PP)
- Overlap welding for base seams
- Near-edge welding on the verge (roof parapets and eaves) up to 100 mm
- Welding on the verge (roof parapets and eaves)
- Welding widths 20, 30, 40 mm.
- Welding with Leister Quality System (LQS) with GPS and automatic data documentation of the seam joint

### 1.2 Non-intended use

Any other use or any use beyond the type of use described is deemed to be a non-intended use.

## 2. Technical data

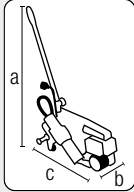
		UNIROOF 700 100 V	UNIROOF 700 120 V	UNIROOF 700 220 – 240 V
	V~	100	120	230
	W	1500	1800	3680
	Hz	50/60		
	°C	100 – 620		
	°F	212 – 1148		
	%	45 – 100		
	m/min	1 – 10		
	ft/min	3.2 – 32.8		
	LpA (dB)	70 (K = 3 dB)		
	kg*	17.0		
	lbs*	37.5		
	a) mm / inch	475 / 18.7		
	b) mm / inch	244 / 9.6		
	c) mm / inch	260 / 10.2		
		 		

		UNIROOF 300 100 V	UNIROOF 300 120 V	UNIROOF 300 220 – 240 V
	V~	100	120	230
	W	1500	1800	3450
	Hz	50/60		
	°C	100 – 580		100 – 600
	°F	212 – 1076		212 – 1112
	%	45 – 100		
	m/min	1 – 10		
	ft/min	3.2 – 32.8		
	LpA (dB)	70 (K = 3 dB)		
	kg*	17.0		
	lbs*	37.5		
	a) mm / inch	475 / 18.7		
	b) mm / inch	244 / 9.6		
	c) mm / inch	260 / 10.2		
		 		

\* Including 3 weights

Subject to change without prior notice.

### 3. Transport



Comply with applicable national regulations regarding the carrying or lifting of loads.  
The weight of your UNIROOF 700/300, including the transport box, is 21.5 kg (17.0 kg without transport box, including 3 weights).

Use only the transport box included in the scope of delivery (see scope of delivery [4.2]) and the handle fitted on the transport box for transporting the hot air welder.



The **hot-air blowers (10)** MUST be allowed to cool down prior to transport.



Never store flammable materials (such as plastic, wood, or paper) in the transport box.



Never use the **carrying handle (5)** on the device or on the transport box for transporting with a crane.



Never lift the hot air welder by the **additional weights (7)**!

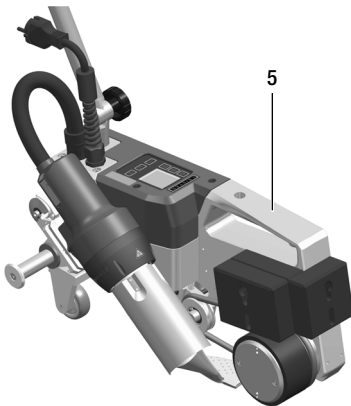

To lift up the hot air welder by hand, use the **carrying handle (5)**.

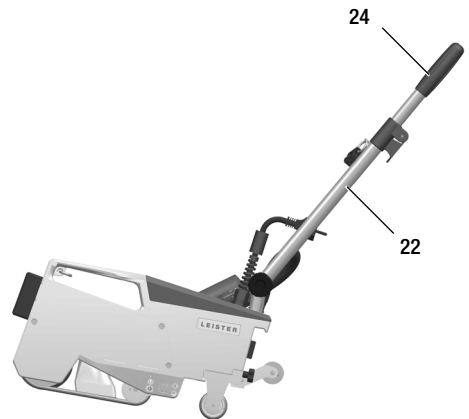

To position the hot air welder, press the **guide bar (22, 24)** and then roll it into the desired welding position.

## 4. Your UNIROOF 700/300

### 4.1 Type plate and identification

The model and serial number are indicated on your device's **type plate (20)**. Transfer this information to your operating instructions; in the event of any inquiries to our representatives or authorized Leister service center, please always refer to this information.

Model:.....

Serial no.:.....

Example:



### 4.2 Scope of delivery (standard equipment in the case)

1 x UNIROOF 700/300 device

- 1 x weight, laterally mounted
- 1 x weight, laterally hooked in
- 1 x weight, mounted at rear
- Movable transport axle (patent EP3 028 836 pending), 220 mm, mounted
- Guide bar, folded in
- Upper handle, separate in the case

1 x wire brush

2 x welding protection plate

1 x hexagonal pin spanner, size 4

1 x safety instructions

1 x Quick Reference Guide

1 x folding brochure



### 4.3 Overview of device parts

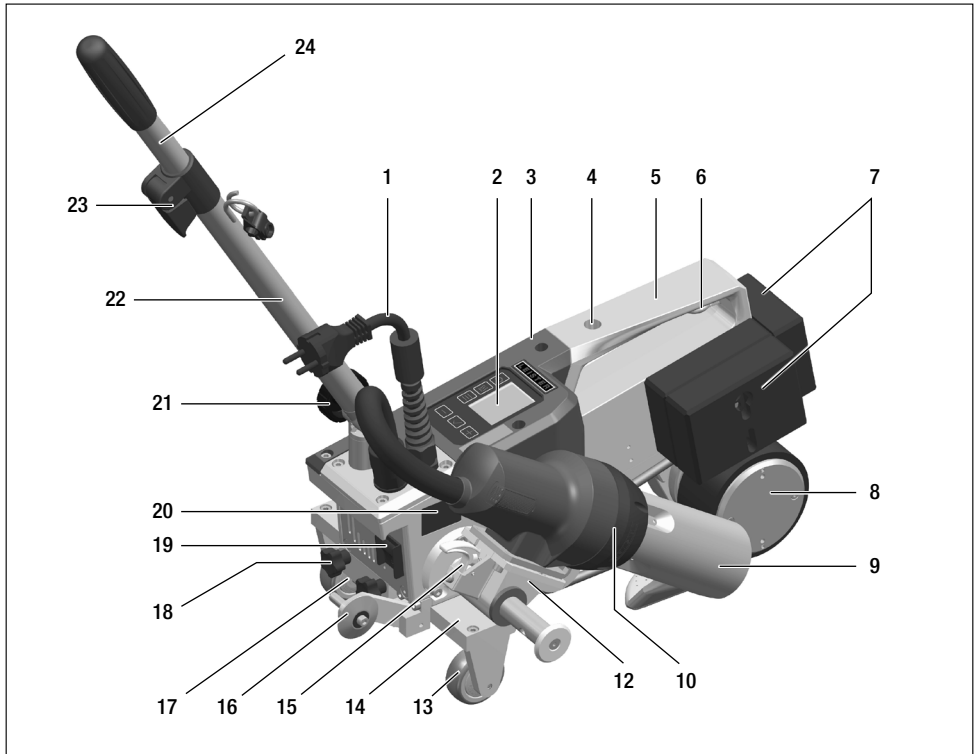

1. Power cord
2. Control panel
3. Housing
4. Opening for fastening any holding/carrying handles and device fastening equipment
5. Carrying handle
6. Holder for power cord (with carabiner for hooking up)
7. Additional weights at the rear/on the side
8. Drive/pressure roller (Patent EP3 028 836 issued)
9. 40 mm welding nozzle
10. Hot air blowers
11. Starting switch
12. Swivel-in mechanics
13. Transport roller
14. Movable transport axis (Patent EP3 028 836 granted)
15. Hot-air blower lock
16. Track guide roller
17. Clamping plate for movable transport axle
18. Star knob screw for detaching the movable transport axle
19. Main switch (On/Off switch)
20. Typeplate with model designation and series marking
21. Locking screw (guide bar)
22. Lower part of guide bar
23. Clamping lever, guide bar, top part
24. Guide bar, top part
25. Spiral holder for power supply cord
26. Press-down belt
27. Deflection roller

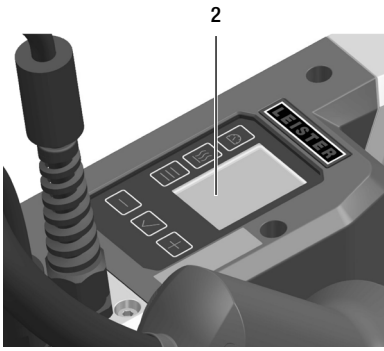

**Control panel (2) UNIROOF 700**

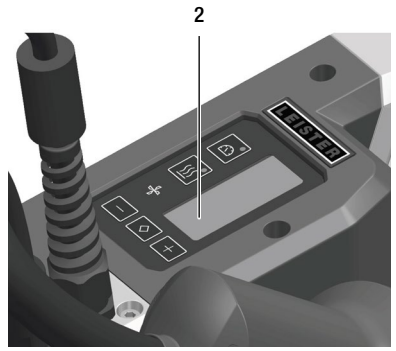

**Control panel (2) UNIROOF 300**

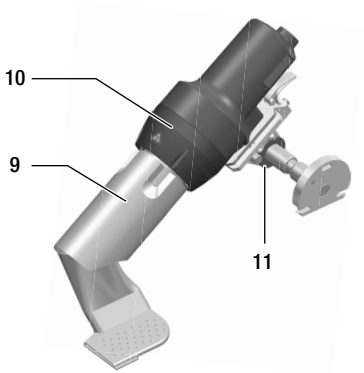

**Welding nozzle (9), hot-air blower (10),  
start switch (11)**

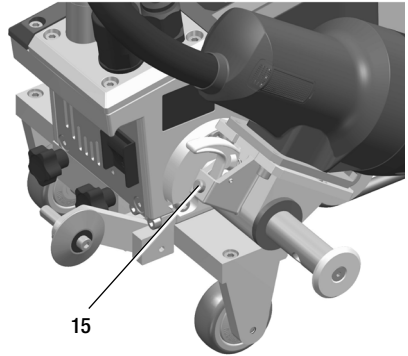

**Hot-air blower lock (15)**

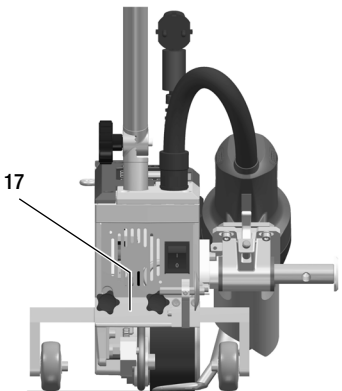

**Clamping plate for movable  
transport axle (17)**

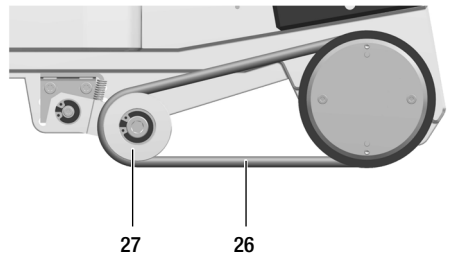

**Hold-down belt (26), deflection roller (27)**

## 5. Settings on the UNIROOF 700/300

### 5.1 Adjusting the welding nozzles

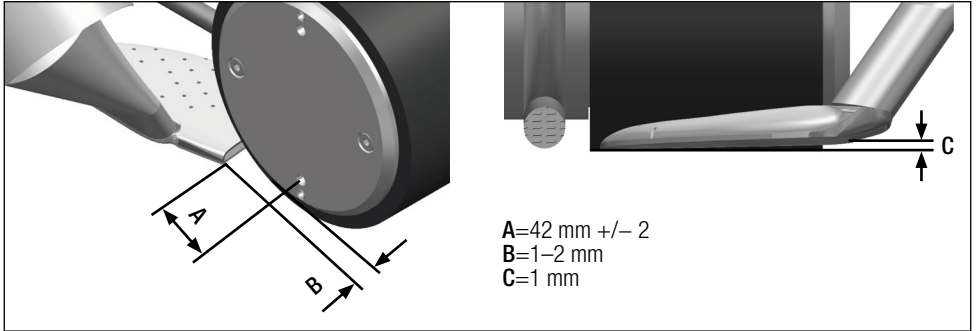

Retool the **drive/pressure roller (8)** and **welding nozzle (9)** to match the desired welding width as needed (see  Retooling for different welding width [5.5]).

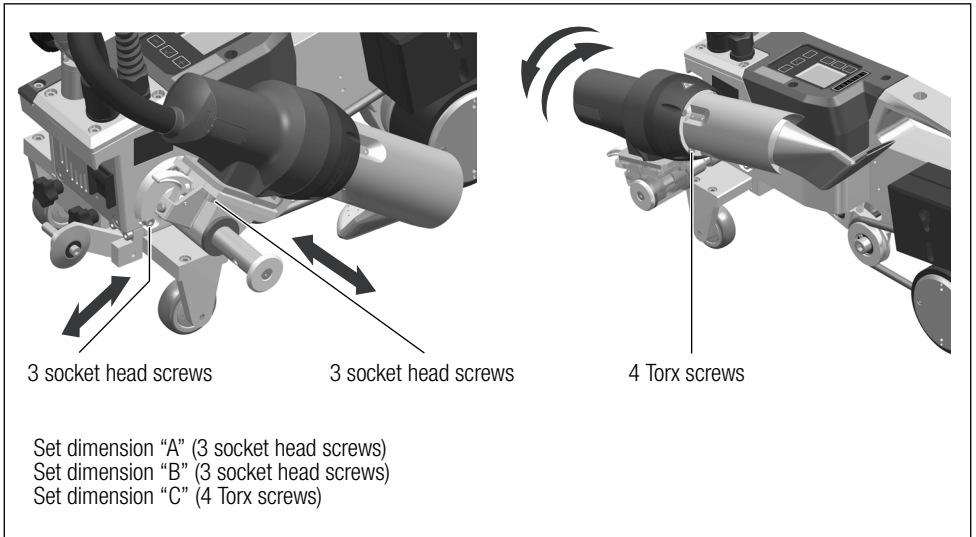

## 5.2 Additional weights for increasing the contact pressure weight

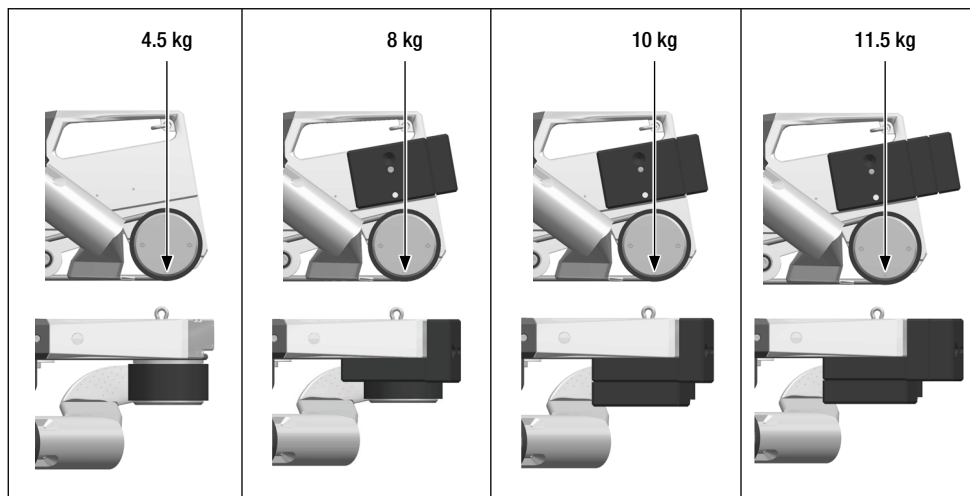

- The weight is transferred to the **drive/pressure roller (8)**.
- As required, the **additional weights (7)** included in the scope of delivery can be attached (weight on the side 2 kg, weights at the rear 1.5 kg each, total 11.5 kg).

## 5.3 Adjusting the guide bar

- Move **guide bar lower part (22)** with **locking screw (21)**, then **guide bar upper part (24)** with **clamping lever (23)** into the desired position (angle).

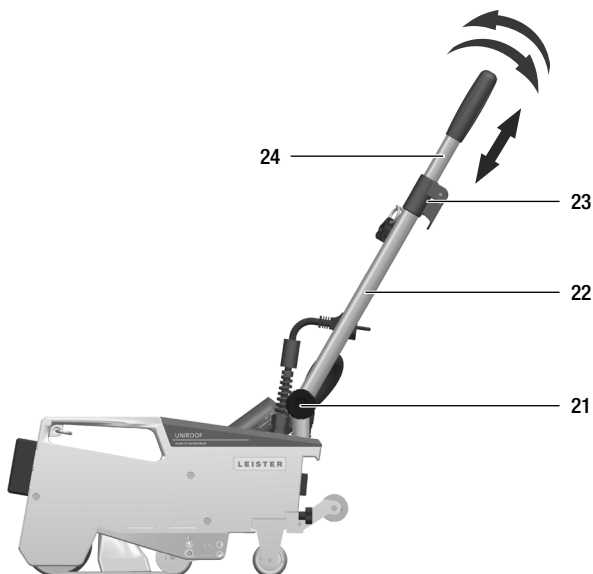

## 5.4 How to set the movable transport axle (patent EP3 028 836 pending)

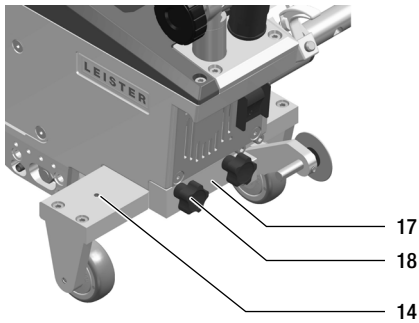

- Loosen **both star grip screws (18)** on the clamping plate for the movable **transport axis (17)**.
- Bring the movable **transport axis (14)** into the required position (see illustration).
- **Re-tighten the star knob screw (18)** on the clamping plate for the movable **transport axis (17)**.

Welding close to edges

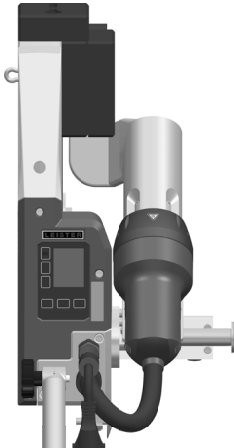

Base-seam welding

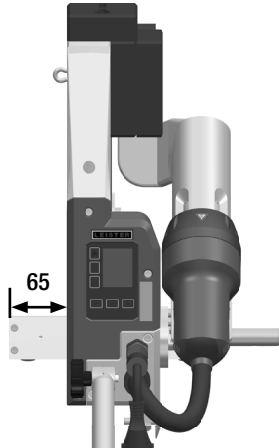

Welding on the verge (parapets and eaves)

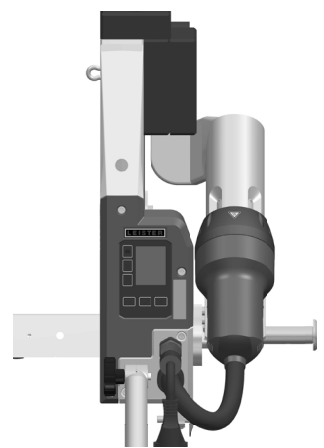

## 5.5 Retooling for different welding width

To retool to a different welding width, proceed in accordance with the sequence described below.

### Step 1: Safety precautions



Allow the device to cool down in cool-down mode.

Before beginning with dismantling work, make sure that **the device has been switched off at the main switch (19)** and that the **power supply cord (1)** is disconnected from the power supply.

### Step 2: Adjusting the roller width (analogous to the 20-, 30-, or 40-mm welding nozzle)

1. Undo the two M4 x 12 cheese-head screws.
2. Remove the cover plate.
3. Replace the intermediate rings of the drive/pressure roller (8) and the **press-down belt (26)**.
4. Mount the cover plate.
5. Retighten the two M4 x 12 cheese-head screws.

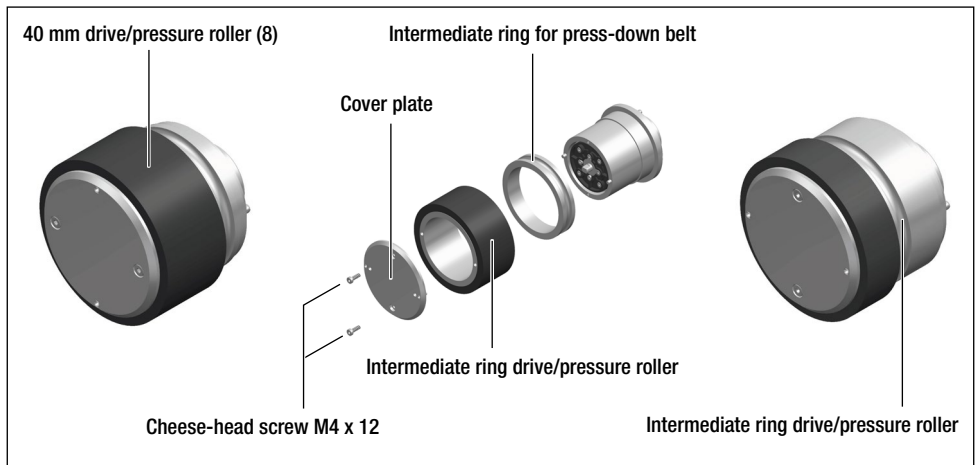

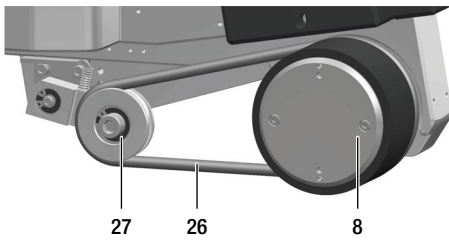

### Step 3: Insert intermediate piece for press-down belt.

1. Remove the **press-down belt (26)**.
2. Undo the two M5 x 16 cheese-head screws.
3. Remove the deflection **roller assembly (27)**.
4. Mount the spacer block (20 or 30 mm) with the two M5 x 16 cheese-head screws.
5. Mount the deflection **roller assembly (27)**.
6. Retighten the two M5 x 16 cheese-head screws.
7. Mount the **press-down belt (26)**.

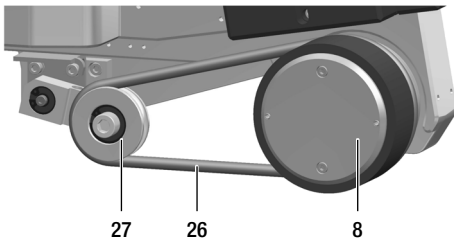
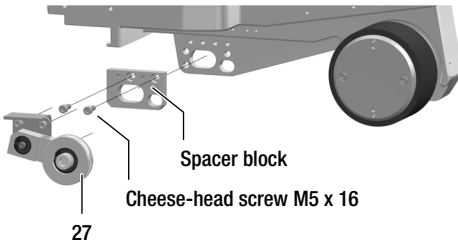

### Step 4: Changing the welding nozzle (20, 30, 40 or 80 mm)

1. Loosen the 4 Torx screws.
2. Remove the currently mounted **welding nozzle (9)**.
3. Insert the desired **welding nozzle (9)**.
4. Adjust the **welding nozzle (9)**  
(see [Adjusting the welding nozzles \[5.1\]](#)).
5. Retighten the 4 Torx screws.

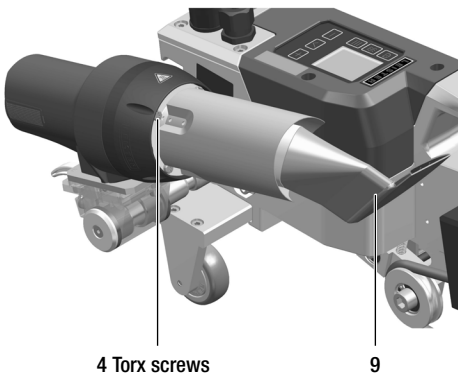

## 6. Commissioning your UNIROOF 700/300

### 6.1 Work environment and safety



#### Health risk

Welding PVC materials creates harmful hydrogen chloride vapors. The hot air welder should be used only in well-ventilated indoor areas.

Read the material safety data sheet from the manufacturer of the material and follow that company's instructions. Be careful not to burn the material during the welding process.



#### Danger of fire and explosion

Never use the hot-air welder in explosive or readily inflammable surroundings. Maintain sufficient distance from combustible materials or explosive gases at all times.



#### Caution

The device should only be used on a horizontal (roof slope up to 30°) and fireproof support.



#### Caution

Comply with national statutory requirements regarding occupational safety (securing personnel or devices).



**Anti-fall protection when working on areas where there is a danger of falling.**

**When welding on roof parapets (parapet, eaves), the hot air welder on the carrying handle (5) must be secured to a stop fixture with horizontal guides (such as rail or rope safety systems) as protection against falling.**

With respect to the safety chain, care must be taken to ensure that all of the safety elements (carabiner hooks, ropes) have a minimum load-carrying capacity of 7 kN in every direction that can be anticipated. For the suspension of the machine, it is mandatory to use clasp carabiners (Twist-Lock or screw types). All safety chain connections must be installed and checked in accordance with manufacturer specifications.

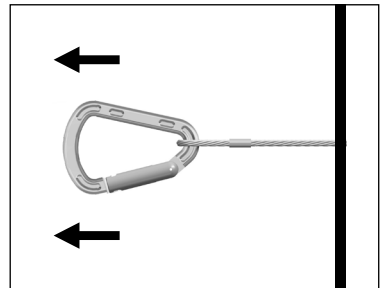
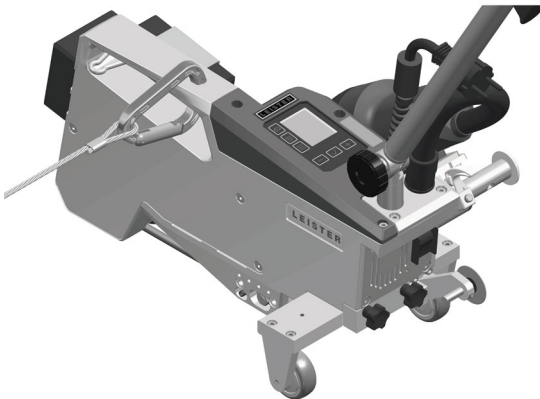



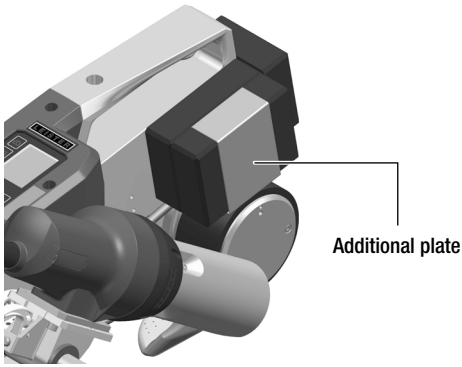

Before each use and after unusual occurrences, the **carrying handle (5)** that is used for fastening the safety rope must be inspected by an individual with expertise in this area. The **carrying handle (5)** is not permitted to exhibit any cracks, corrosion, notches or other material faults.

The additional weights must be reliably secured with the safety clamps (1 each at the front and rear) provided for this purpose.



**Caution**

Only secure the hot air welding machine by the **carrying handle (5)**.

**Caution**

The hot wedge welding machine must never be fastened to single anchoring points which allow ropes to sag. The connection equipment must always be set to the shortest length possible in order to eliminate any chance of falling over the edge of the parapet.

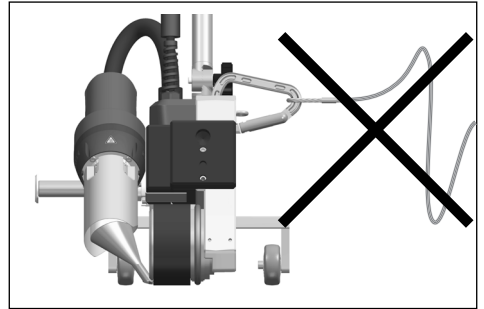
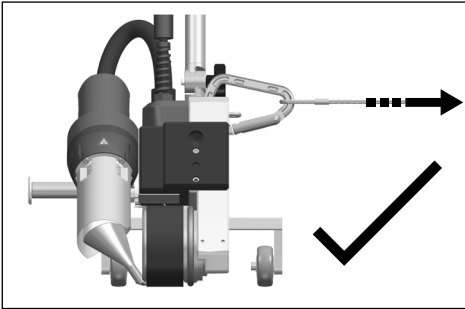

**Caution**

The effects of gravity mean a danger of uncontrolled falling or sinking. The securing point is not designed to withstand the shock-like stress of an abrupt fall.

Absolutely contact the manufacturer if anything is unclear during installation or operation.

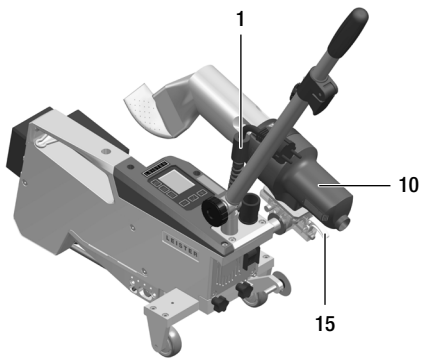

In cases of supply power failure, during work interruptions or when cooling down, you must swivel the **hot-air blowers (10)** into park position and allow them to engage there.

Take care to ensure that the **hot-air blower lock (15)** engages.

### Power cord and extension cable

- The nominal voltage specified on the device (see  technical data [2]) must match the supply voltage.
- The **power cord (1)** must be able to move freely and must not hinder the user or third parties during work (trip hazard).
- The extension cables must be authorized for the utilization site (such as, outdoors) and be marked accordingly. Take the necessary minimum cross-section for extension cables into account as required.

### On-site generators for power supply

When using on-site generators as a power supply, please ensure that the on-site generators are grounded and equipped with residual-current circuit breakers.

For the nominal output of the power plants, the formula “2 x nominal output of the hot-air welder” applies.

## 6.2 Operating readiness

Hook up the strain relief of the **power supply cord (1)** into the **spiral holder (25)** and then check the basic setting of the **welding nozzle (9)**.

### 6.3 Positioning the device

- Check whether the material to be welded is clean between the overlap on both the upper and lower sides.
- Then check whether the **welding nozzle (9)**, **drive/pressure roller (8)**, **deflection roller (27)** and **press-down belt (26)** are clean.
- Swivel the **hot-air blower (10)** so it engages in the park position.
- Now raise up the hot air welder by the **guide bar (22, 24)** and move the device to the desired welding position.
- Now position the welding plate (see  scope of delivery[4.2]) and then swivel the **track guide roller (16)** downwards.
- Take care to ensure that the **track guide roller (16)** is positioned parallel to the **drive/pressure roller (8)**.

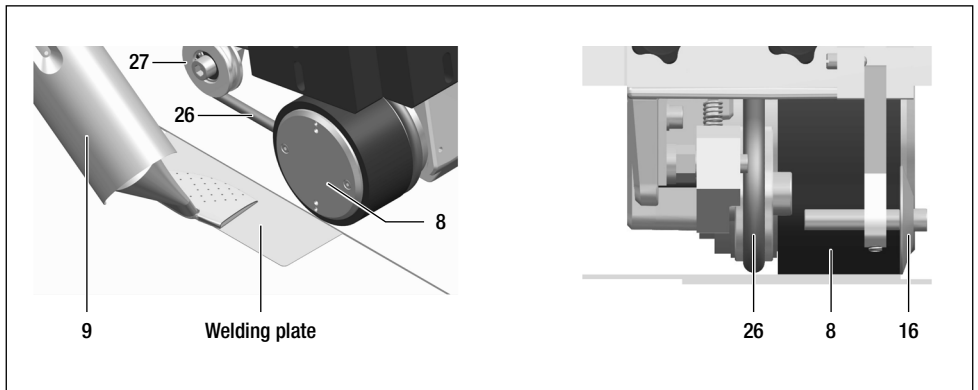

## 7. Operation of your UNIROOF 700

### 7.1 Starting the device

- Once you have prepared the working area and the hot air welder in accordance with the description, connect the hot air welder to the supply voltage.
- Use the **main switch (19)** to switch the hot-air welder on.



After startup, the **Start screen** will appear briefly in the display, with the version number of the current software release and the device designation.

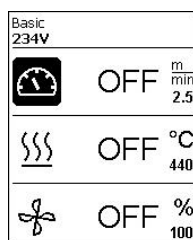

If the device was allowed to cool down beforehand, this will be followed by a static display of the setpoints of the most recently used profile (the Basic profile is displayed when the device is first commissioned).

**The heating is not yet switched on at this stage.**

- Select the desired welding profile or define the welding parameters individually.
- Now switch the heating on with the *heating On/Off button (31)*.

## 7.2 Welding sequence

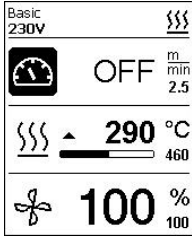

### Preparing for welding

As soon as you have switched on the heating, you will see a **dynamic display of the current air temperature with a progress bar** (setpoint and actual values).

- Make sure that the welding temperature has been reached before commencing work (the heating time is 3–5 minutes).
- Now carry out test welds in accordance with the welding instructions of the material manufacturer and/or national standards or regulations and inspect the results. Adjust the welding profile as required.

### Start welding

- Pull the **hot-air blower lock lever (15)**, lower the **hot-air blower (10)** and guide the **welding nozzle (9)** between the overlapping sheets up to the stop.
- The drive motor starts automatically as soon as the **hot-air blower (10)** is engaged.
- You can also start the device manually with the *Drive On/Off button (30)*.
- Guiding the device during the welding process
- Guide the hot-air welder by the **guide bar (22, 24)** or by the **carrying handle (5)** along the overlap and also observe the position of the **track guide roller (16)**.
- Avoid applying pressure to the **guide bar (22, 24)** during the welding process, since this may lead to welding faults.

## 7.3 Finishing welding

- After finishing welding, pull the **hot-air blower lock lever (15)**, extend the **hot-air blower (10)** up to the stop (this stops the drive motor) and swivel it upwards until it engages.
- Then swivel the **track guide roller (16)** upwards.

## 7.4 Switching off the device / Maintenance

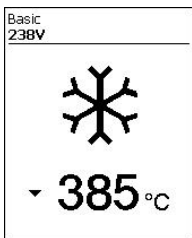

Use the *Heating On/Off button (31)* to switch off the heating, so the **welding nozzle (9)** cools down.

This will trigger the cool-down mode.

- The blower switches off automatically after approx. 6 minutes.
- Now switch off the device with the **main switch (19)** and disconnect the **power cord (1)** from the electrical network.



- Wait until the device has cooled down.
- Check the **power cord (1)** and plug for electrical and/or mechanical damage.
- Use a wire brush to clean the **welding nozzle (9)**.

## 8. Quick Reference Guide UNIROOF 700

### 8.1 Switching on/Starting

1. Make sure that the **main switch (19)** is switched off and the **hot-air blowers (10)** are in parking position. Connect the supply voltage plug.
2. Switch on the **main switch (19)**.
3. **Switch on the heating with the *heating On/Off (31)* button**; wait 3–5 minutes until the desired temperature is reached.
4. Swivel the **hot-air blower (10)** downwards (**machine starts automatically**).

### 8.2 Switching off

1. Swivel the **hot-air blowers (10)** upwards (**stops the drive motor**).
2. **Switch off the heating with the *Heating On/Off button (31)*** and wait for the cooling process to finish (approx. 5 minutes).
3. **Switch off the main switch (19)**.
4. Pull out supply voltage plug

**UNIROOF 300/700**  
Quick Guide



User Manual: [leister.com/uniroof-700](http://leister.com/uniroof-700)



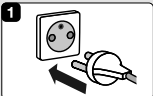

Download myLeister App

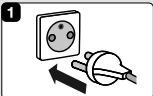

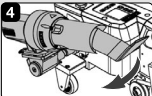



- 1 
- 2 
- 3 
- 4 



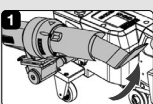
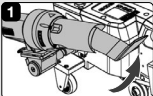

- 1 
- 3 

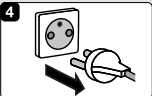

- 1 
- 2 
- 3 
- 4 



- 2 
- 4 

QG UNIROOF 300/700 / Art. 169.182 / 09.2021

## 9. Control panel of the UNIROOF 700

The **control panel (2)** is comprised of the **function buttons** with which you control the various menu functions, and the **display** where the respectively selected setting, menu options or the values valid for the running time are displayed.

### 9.1 Function buttons

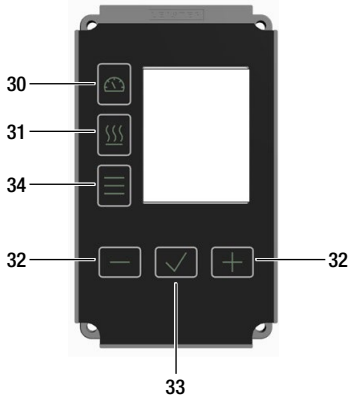

- 30. Button *Drive On/Off*
- 31. Button *Heating On/Off*
- 32. Buttons *Back/reduce* and *Advance/increase*
- 33. Button *Confirm*
- 34. Button *Menu*

### Multiple allocation of function buttons Control panel (2) / Symbols Display

Symbol	Name	In the work display (41)	In the menu, after pressing the button (34), briefly press
	Button <i>Drive On/Off (30)</i>		Selection of line when editing text
	Button <i>Heating On/Off (31)</i>		Selection of line when editing text
	Buttons <i>Plus/Minus (32)</i>		
	short press	Sets the required setpoint in 0.1m/min, 10°C or 5% steps	Changing the position/ changing the menu, setting parameters
	press and hold	Rapid setting of the required setpoint	Changing the position/ changing the menu, setting parameters
	Button <i>Confirm (33)</i>	The set value is applied and shown in the Menu selection (42).	The desired function or menu is executed.
	Button <i>Menu (34)</i>	Switching to the menu area	Return to the working display

## 9.2 Display

The display is subdivided into two display areas:

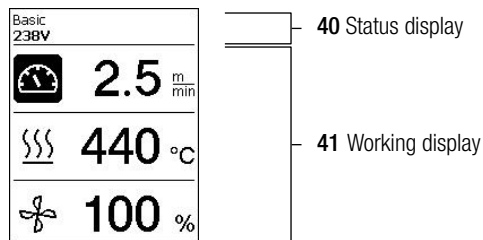

## 9.3 Setting the welding parameters

To adjust a welding parameter before welding, proceed as follows:

Example for setting the welding temperature

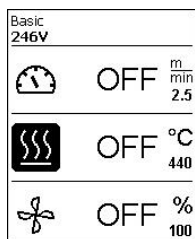
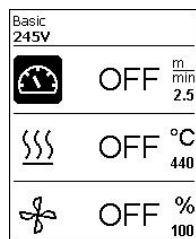

Press the *Minus (32)* button to select the temperature and then the *Confirm (33)* button.

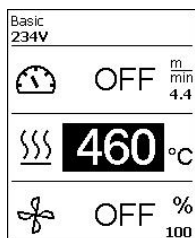
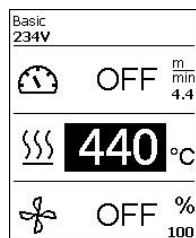

You can now use the *Minus/Plus (32)* buttons to set the desired temperature setpoint. If you do not make any more entries, the cursor automatically jumps back to the temperature symbol. Use the *Minus/Plus (32)* buttons to select the next welding parameter, if desired.



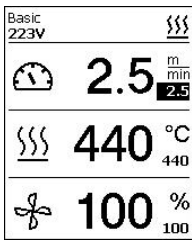

During the welding process, the cursor is always on the Drive icon. **You can adjust the welding speed at any time using the *Minus/Plus (32)* buttons.**

If you want to adjust another parameter, first press the *Confirm (33)* button. Then you can select the desired parameter with the *Minus (32)* button.

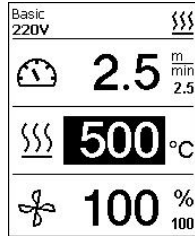
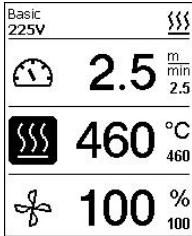

Now press the *Confirm (33)* button.

You can now use the *Minus/Plus (32)* buttons to set the desired setpoint. If you do not make any further entries, the cursor automatically jumps back to the Drive icon if Info Mode is not switched on.

#### 9.4 Display symbols of the status display (Display 40)

The Status display is subdivided into a left-hand (1) and a right-hand area (2).

Status display 1 / Left	
Profile name	Displays the name of the selected currently valid welding profile (such as Basic). If a profile name contains more than 6 characters, the first 6 characters are shown first, one after the other, followed by the remaining 6 characters. The system presents the first 6 characters afterwards.
Voltage	Display of the supply voltage
Status display 2 / Right	



Warning present



Data recording



Overvoltage



Eco mode



GPS data reception



Undervoltage



WLAN



Stop Device on Alert switched on











Heating

## 9.5 Display symbols of the work display (Display 41)

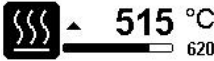
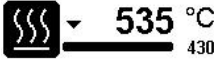
2.5 $\frac{m}{min}$
440 °C
100 %

During operation, the setpoints of the welding parameters (drive in m/min or ft/min, temperature in degrees Celsius or Fahrenheit, air volume in percent and, if applicable, information notes (see  Info Mode: Show current values [10.10]) are displayed.

Use the *Minus/Plus* (32) buttons to switch between the welding parameters. By pressing the *Confirm* (33) button, the respective parameter can be individually adjusted with the *Minus/Plus* (32) buttons.

	Symbol drive/welding speed [m/min or ft/min]
	Symbol air temperature [°C or °F]
	Symbol air volume [%]
	<b>Welding temperature too low, heating process up arrow</b> and progress bar show that the desired <b>higher temperature</b> has not yet been achieved. The flashing number above the progress bar designates the currently achieved actual value (345); the value to the right of the bar (440) shows the nominal value of the selected welding profile or of the individual setting.
	<b>Welding temperature too high, cooling process down arrow</b> and progress bar show that the desired <b>lower temperature</b> has not yet been achieved. The flashing value above the bar designates the currently achieved actual value (485); the value to the right of the bar (440) shows the nominal value of the selected welding profile or of the individual setting.
	Symbol for Cool-down mode
	Symbol for hardware error message. The device is no longer ready for operation. Contact an authorized Leister Service Center. (Note the respective error code in Section  Warning and Error Messages).
	Symbol for <b>Hardware error message</b> (heating element is defective). The device is no longer ready for operation. Contact an authorized Leister Service Center.
	Symbol for <b>Overtemperature warning message</b> . Allow the device to cool down.

# 10. Settings and functions of the UNIROOF 700 software

## 10.1 Overview menu navigation UNIROOF 700

**Note:** Pressing the  Menu (34) button will return you to the working display in each menu item.

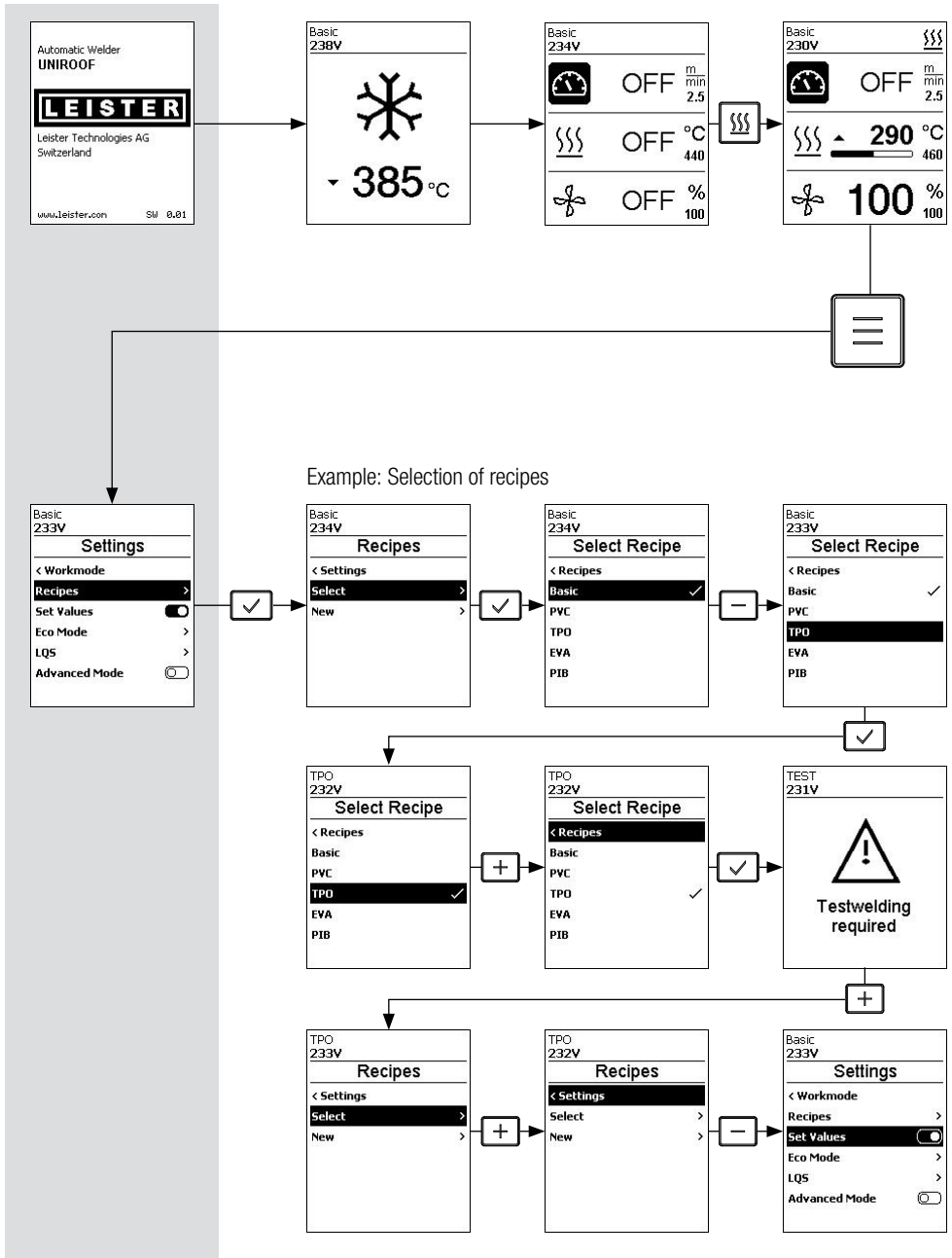

## Switching off Target and Actual Value Display (see 10.4)

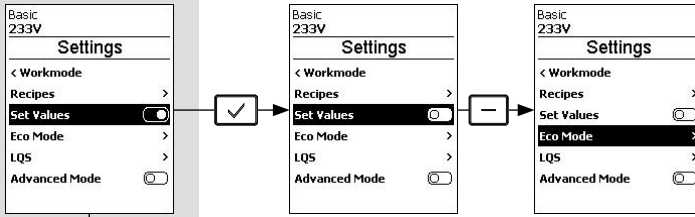

## Switching on ECO Mode (see 10.5)

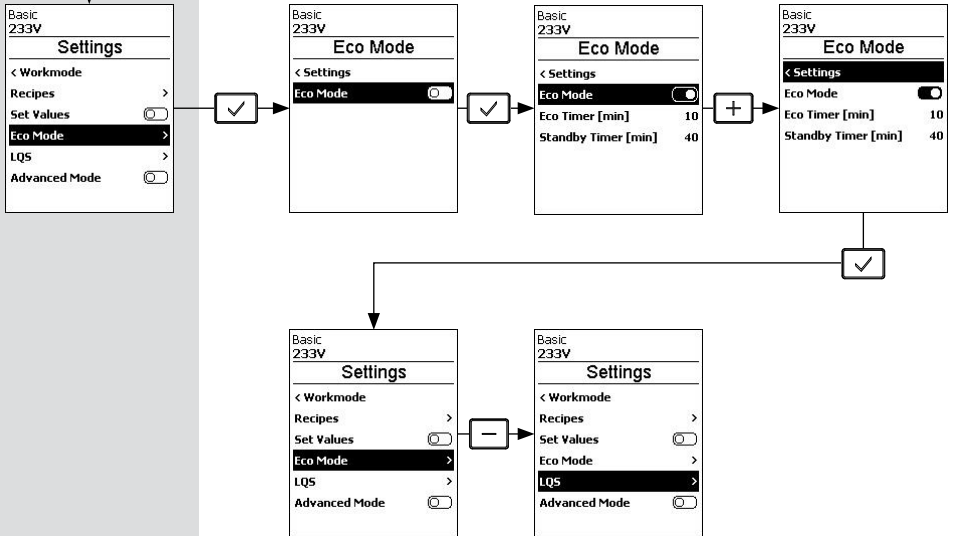

### Switching off Data Recording (see 10.6)

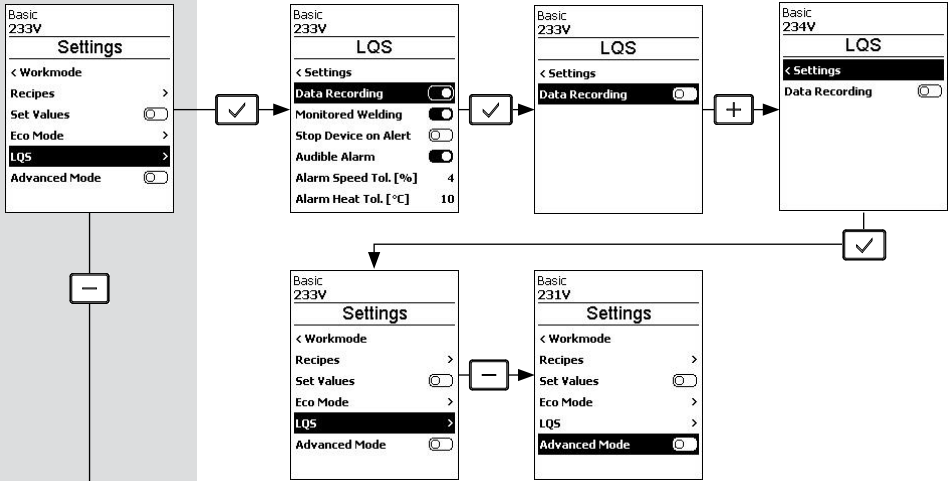

### Switching on Advanced Mode (see 10.7)

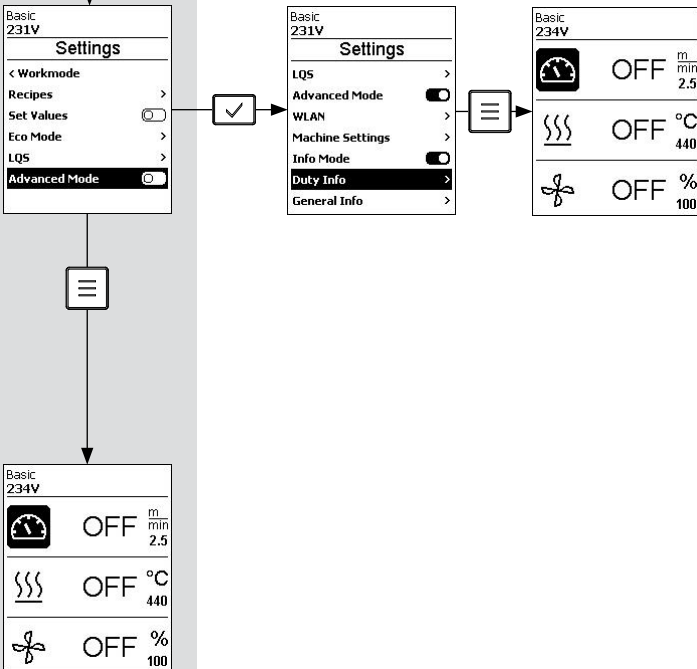

## 10.2 Basic settings and Advanced Mode



From the default setting via the menu Settings, you can access the recipes, display of the setpoints, Eco Mode and Advanced Mode.



If you activate Advanced Mode, further information and setting options are available.

## 10.3 Recipes



Recipes can be found under Select for saved recipes. To select a recipe, press the Confirm (33) button. If no recipes are available, you can create recipes under New

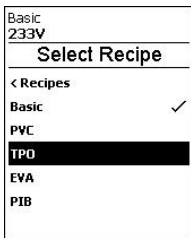

Use the Minus/Plus (32) buttons to select the desired recipe. By pressing the Confirm (33) button, the corresponding recipe is accepted.

Exit the menu by pressing the Menu (34) button.

The message appears that a test weld must be carried out.



You can create a recipe yourself under the New menu item.



To change the name, press the *Confirm (33)* button.

Use the *Minus/Plus (32)* buttons to select characters or digits and accept with the *Confirm (33)* button. Line change with the *drive (30)* or *heating (31)* buttons.

To save the selected name and exit the character editor, select the check mark and then accept it with the *Confirm (33)* button.

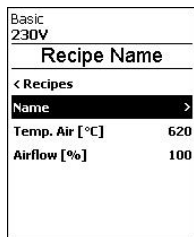

You can adjust the parameters of your own recipes at any time.

To do this, in the menu Recipes select the submenu Edit by pressing the *Minus (32)* button.

Press the *Confirm (33)* button.

All customizable recipes are displayed.

Use the *Minus (32)* button to select the recipe to be adjusted.

Press the *Confirm (33)* button.

Use the *Minus (32)* button to select the parameter to be adjusted and then press the *Confirm (33)* button.

You can now set the desired value with the *Minus/Plus (32)* buttons.

The set value is accepted with the *Confirm (33)* button.

To save the setting, use the *Minus (32)* button to select the Save Recipe menu item and then press the *Confirm (33)* button.

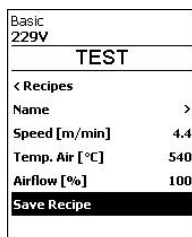
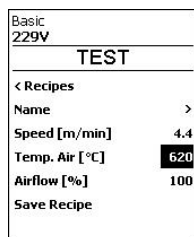
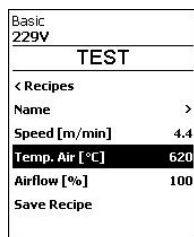
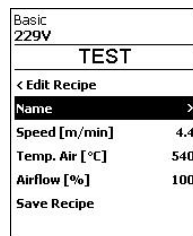
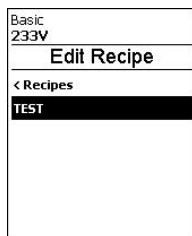

## 10.4 Displaying target values (Set values)

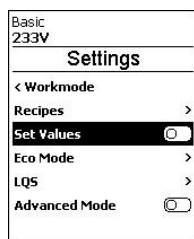

Factory activated

If you do not wish to display the setpoint and actual value on the working display (41), you can deactivate Set Values by pressing the *Confirm (33)* button.



If the Set Values function is activated (factory setting), the actual temperature (high) and the target temperature (low) are shown in the work display (41).

This applies analogously for drive (m/min) or air volume (percent).



## 10.5 Eco mode



Switched off at the factory

You can activate Eco Mode by pressing the *Confirm (33)* button. You can set the desired time interval individually by selecting the value to be adjusted with the *Minus/Plus (32)* buttons. Press the *Confirm (33)* button. You can now set the value individually with the *Minus/Plus (32)* buttons. To accept the set value, press the *Confirm (33)* button again.

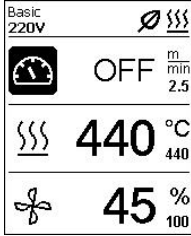

If you have activated Eco Mode and the device remains inactive for the set period of time, you will automatically switch to standby mode. The air volume is automatically reduced to 45%. In the working display (41), the standby mode is displayed with the corresponding symbol.

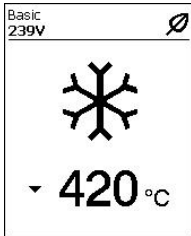

After the standby timer has expired without activity, the cooling process is initiated. You can interrupt the process with the *Heating On/Off (31)* button.

## 10.6 Settings for LQS data recording

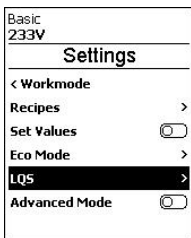

Select the *LQS* menu item in the menu by pressing the *Minus (32)* button. Then press the *Confirm (33)* button.

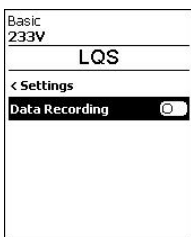

To switch on data recording, press the *Confirm (33)* button.

## Monitored Welding

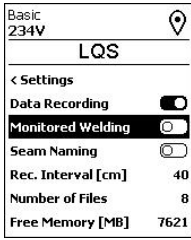

If Monitored Welding is switched on, limit values of the recorded welding parameters are logged. Select the Monitored Welding menu item in the menu by pressing the *Minus (32)* button. Then press the *Confirm (33)* button.

## Stop Device on Alert

If Stop Device on Alert is switched on, the heating and drive are switched off if the limit value is exceeded. The limit values are specified.

The maximum permissible temperature deviation of the hot-air blower is 10°C; the permissible deviation of the drive speed is 4% and the fan speed is 4%.

If the limit value is exceeded, the machine stops automatically after 30 seconds. The Stop Device on Alert symbol is displayed in the status display (40).

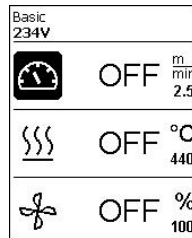

## Audible Alarm



If the Audible Alarm is switched on, an acoustic alarm sounds when the limit value is exceeded. To activate the Audible alarm, select the Audible Alarm menu item in the menu by pressing the *Minus (32)* button and then press the *Confirm (33)* button. If Stop Device on Alert is not enabled, you can set the alarm limit deviations individually.

Individually set limit deviation setting for Speed, Heat, and Air when Stop Device on Alert is disabled.

Select the limit value to be set by pressing the *Minus (32)* button and then press the *Confirm (33)* button. Use the *Minus/Plus (32)* button to set the limit value.

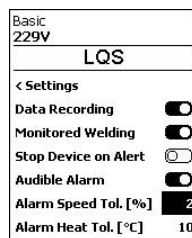
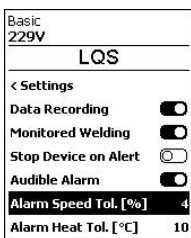

## Seam Naming

Basic 234V	
<b>LQS</b>	
Stop Device on Alert	<input type="checkbox"/>
Audible Alarm	<input checked="" type="checkbox"/>
Alarm Speed Tol. [%]	4
Alarm Heat Tol. [°C]	10
Alarm Vol. Tol. [%]	4
Seam Naming	<input type="checkbox"/>
Rec. Interval [cm]	40

Basic 234V	
<b>LQS</b>	
Stop Device on Alert	<input type="checkbox"/>
Audible Alarm	<input checked="" type="checkbox"/>
Alarm Speed Tol. [%]	4
Alarm Heat Tol. [°C]	10
Alarm Vol. Tol. [%]	4
Seam Naming	<input checked="" type="checkbox"/>
Seam Name	>

Press the *Minus (32)* button to select Seam Naming and then press the *Confirm (33)* button.

## Seam Name

Basic 232V	
<b>LQS</b>	
Audible Alarm	<input checked="" type="checkbox"/>
Alarm Speed Tol. [%]	4
Alarm Heat Tol. [°C]	10
Alarm Vol. Tol. [%]	5
Seam Naming	<input checked="" type="checkbox"/>
Seam Name	>
Rec. Interval [cm]	40

Basic 228V	
<b>Seam Name</b>	
< Data Recording	
Seam Name	>

Press the *Minus (32)* button to select the Seam Name and then press the *Confirm (33)* button.

To adjust the name, press the *Confirm (33)* button. Use the *Minus/Plus (32)* button to select characters or digits and accept with the *Confirm (33)* button. Line change with the buttons *drive (30)* or *heating (31)*.

To save the selected name and exit the character editor, select the check mark and then accept it with the *Confirm (33)* button.

Basic 230V	
SEAM-1	
1 2 3 4 5 6 7 8 9 0	
Q W E R T Z U I O P	
A S D F G H J K L	
↑ Y X C V B N M ◀	
-   +   →	
✓	

## Rec. Interval

Basic 232V	
<b>LQS</b>	
Alarm Speed Tol. [%]	4
Alarm Heat Tol. [°C]	10
Alarm Vol. Tol. [%]	5
Seam Naming	<input checked="" type="checkbox"/>
Seam Name	>
Rec. Interval [cm]	40
Number of Files	13

Basic 232V	
<b>LQS</b>	
Alarm Speed Tol. [%]	4
Alarm Heat Tol. [°C]	10
Alarm Vol. Tol. [%]	5
Seam Naming	<input checked="" type="checkbox"/>
Seam Name	>
Rec. Interval [cm]	20
Number of Files	13

Select the Rec. menu item in the menu by pressing the *Minus (32)* button interval. Then press the *Confirm (33)* button.

Use the *Minus/Plus (32)* button to set the value for the recording interval. Pressing the *Confirm (33)* button accepts the set value.

## Number of Files

Basic 234V	
LQS	
Alarm Heat Tol. [°C]	10
Alarm Vol. Tol. [%]	5
Seam Naming	<input checked="" type="checkbox"/>
Seam Name	>
Rec. Interval [cm]	20
Number of Files	13
Free Memory [MB]	7620

Select the *Number of Files* menu item in the menu by pressing the *Minus (32)* button.

The number of recorded files is displayed.

## Free memory

Basic 234V	
LQS	
Alarm Vol. Tol. [%]	5
Seam Naming	<input checked="" type="checkbox"/>
Seam Name	>
Rec. Interval [cm]	20
Number of Files	13
Free Memory [MB]	7620
GPS	<input type="checkbox"/>

Select the *Free Memory* menu item in the menu by pressing the *Minus (32)* button. The free memory capacity is displayed.

## GPS

Basic 234V	
LQS	
Alarm Vol. Tol. [%]	4
Seam Naming	<input checked="" type="checkbox"/>
Seam Name	>
Rec. Interval [cm]	40
Number of Files	8
Free Memory [MB]	7621
GPS	<input type="checkbox"/>

Basic 229V	
LQS	
Seam Naming	<input checked="" type="checkbox"/>
Seam Name	>
Rec. Interval [cm]	20
Number of Files	1
Free Memory [MB]	7621
GPS	<input checked="" type="checkbox"/>
GPS Position	>

Switched off at the factory

To switch on GPS, select the *GPS* menu item in the menu by pressing the *Minus (32)* button; then press the *Confirm (33)* button. The GPS coordinates of the welds are now displayed in the welding protocol.

## GPS position

Basic 229V	
LQS	
Seam Naming	<input checked="" type="checkbox"/>
Seam Name	>
Rec. Interval [cm]	20
Number of Files	1
Free Memory [MB]	7621
GPS	<input checked="" type="checkbox"/>
GPS Position	>

Basic 235V	
GPS Position	
N 46° 54.8271'	
Longitude	
E 8° 15.5502'	
Elevation	
468.19 m	
Satellites in view	10
HDOP	1.91

Select the *GPS Position* menu item in the menu by pressing the *Minus (32)* button. Then press the *Confirm (33)* button.

With the *Minus/Plus (32)* button you can view the GPS position data if there is a connection to the satellite.

The symbol for GPS reception is displayed in the status display (40). If the symbol is filled out in black, satellites were found. If the symbol is not filled out, satellites are searched for.

## 10.7 Advanced mode settings

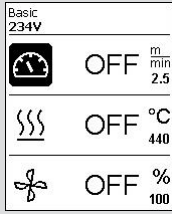

Press 4 times

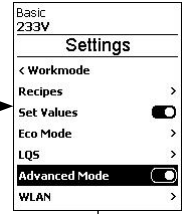
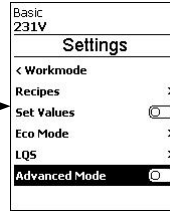

Example: Activate WLAN

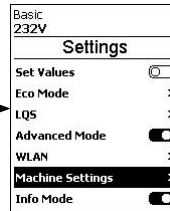
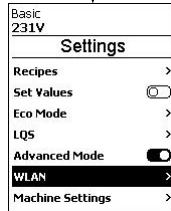
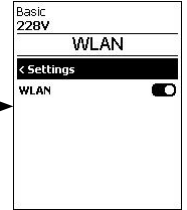
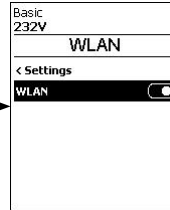
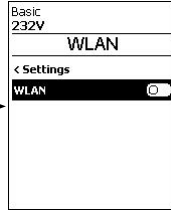

### Example: Setting the time

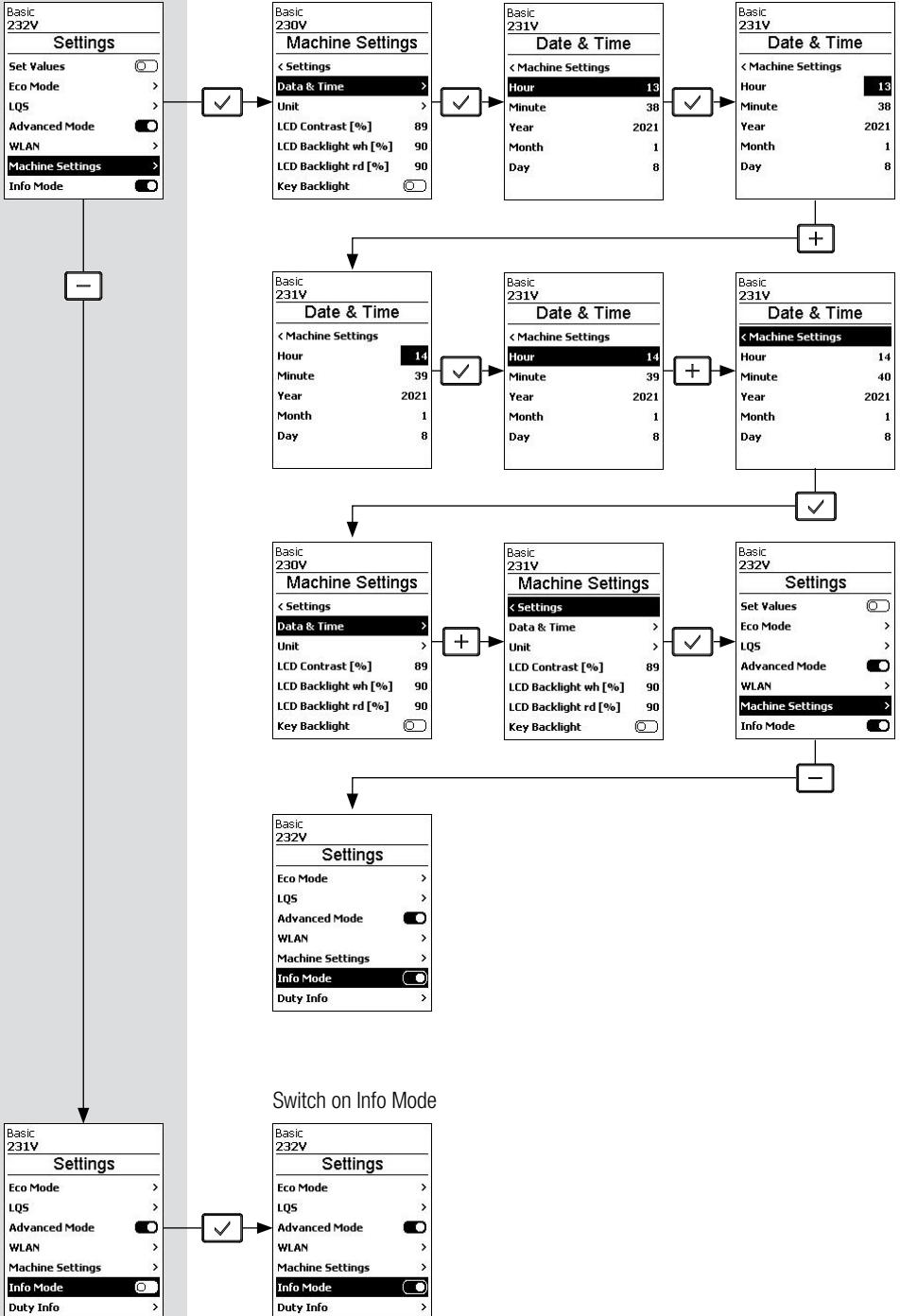

### Switch on Info Mode

### Reset distance counter

Basic 232V
<b>Settings</b>
LQS >
Advanced Mode <input type="checkbox"/>
WLAN >
Machine Settings >
Info Mode <input type="checkbox"/>
<b>Duty Info &gt;</b>
General Info >

-

Basic 229V
<b>Duty Info</b>
< Settings
Hours Machine [h] 4
Hours Drive [min] 15
Hours Blower [h] 2
Trip Distance [km] 0.04
Total Distance [km] 0.04

Basic 229V
<b>Duty Info</b>
< Settings
Hours Machine [h] 4
Hours Drive [min] 15
Hours Blower [h] 2
<b>Trip Distance [km] 0.04</b>
Total Distance [km] 0.04

Basic 229V
<b>Duty Info</b>
< Settings
Hours Machine [h] 4
Hours Drive [min] 15
Hours Blower [h] 2
Trip Distance [km] <input type="checkbox"/>
Total Distance [km] 0.04

+

Basic 229V
<b>Duty Info</b>
< Settings
Hours Machine [h] 4
Hours Drive [min] 15
Hours Blower [h] 2
Trip Distance [km] <input type="checkbox"/>
Total Distance [km] 0.04

Basic 228V
<b>Duty Info</b>
< Settings
Hours Machine [h] 4
Hours Drive [min] 15
Hours Blower [h] 2
<b>Trip Distance [km] 0.00</b>
Total Distance [km] 0.04

Basic 229V
<b>Duty Info</b>
< Settings
Hours Machine [h] 4
Hours Drive [min] 15
Hours Blower [h] 2
Trip Distance [km] 0.00
Total Distance [km] 0.04

+

Basic 232V
<b>Settings</b>
LQS >
Advanced Mode <input type="checkbox"/>
WLAN >
Machine Settings >
Info Mode <input type="checkbox"/>
<b>Duty Info &gt;</b>
General Info >

Basic 232V
<b>Settings</b>
Advanced Mode <input type="checkbox"/>
WLAN >
Machine Settings >
Info Mode <input type="checkbox"/>
<b>Duty Info &gt;</b>
General Info >
Warnings >

### General information

Basic 232V
<b>Settings</b>
Advanced Mode <input type="checkbox"/>
WLAN >
Machine Settings >
Info Mode <input type="checkbox"/>
Duty Info >
<b>General Info &gt;</b>
Warnings >

Basic 229V
<b>General Info</b>
< Settings
<b>Firmware HMI V0.08</b>
Firmware Machine V0.08
Production Year 2020
Production Month 1
Production Day 1
Production Number 0000

Basic 229V
<b>General Info</b>
< Settings
Firmware HMI V0.08
Firmware Machine V0.08
Production Year 2020
Production Month 1
Production Day 1
Production Number 0000

Basic 232V
<b>Settings</b>
Advanced Mode <input type="checkbox"/>
WLAN >
Machine Settings >
Info Mode <input type="checkbox"/>
Duty Info >
<b>General Info &gt;</b>
Warnings >

-

Basic 232V
<b>Settings</b>
Advanced Mode <input type="checkbox"/>
WLAN >
Machine Settings >
Info Mode <input type="checkbox"/>
Duty Info >
General Info >
<b>Warnings &gt;</b>

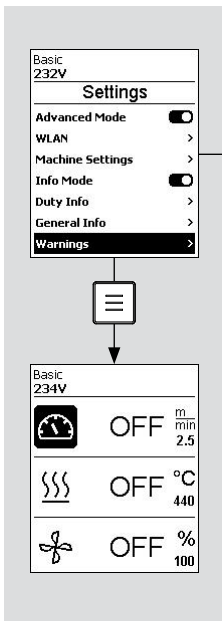

## Warnings

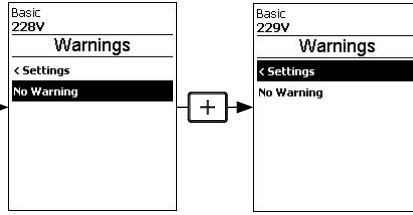

**Note:** Pressing the  *Menu (34)* button will return you to the working display in each menu item.

If you have activated Advanced Mode, additional menu options are available.

## 10.8 WLAN settings

Switched off at the factory



Select the *WLAN* menu item in the menu by pressing the *Minus (32)* button. Then press the *Confirm (33)* button.

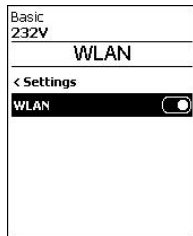
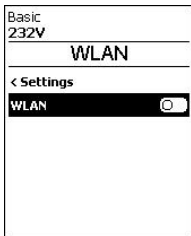

To switch on the WLAN, press the *Confirm (33)* button.



## 10.9 Machine settings

Basic 232V
<b>Settings</b>
Set Values <input type="checkbox"/>
Eco Mode >
LQS >
Advanced Mode <input checked="" type="checkbox"/>
WLAN >
<b>Machine Settings &gt;</b>
Info Mode <input checked="" type="checkbox"/>

Basic 230V
<b>Machine Settings</b>
< Settings
<b>Data &amp; Time &gt;</b>
Unit >
LCD Contrast [%] 89
LCD Backlight wh [%] 90
LCD Backlight rd [%] 90
Key Backlight <input type="checkbox"/>

Select the *Machine Settings* menu item in the menu by pressing the *Minus (32)* button. Then press the *Confirm (33)* button.

### Date and time setting

Basic 230V
<b>Machine Settings</b>
< Settings
<b>Data &amp; Time &gt;</b>
Unit >
LCD Contrast [%] 89
LCD Backlight wh [%] 90
LCD Backlight rd [%] 90
Key Backlight <input type="checkbox"/>

Basic 231V
<b>Date &amp; Time</b>
< Machine Settings
<b>Hour 13</b>
Minute 38
Year 2021
Month 1
Day 8

Select the *Date & Time* menu item in the menu by pressing the *Minus (32)* button. Then press the *Confirm (33)* button.

Here you can set the hour, minute, year, month and day. Use the *Minus/Plus (32)* buttons to select the value you wish to change. Then press the *Confirm (33)* button. Then set the desired value with the *Minus/Plus (32)* buttons. Then save the set value by pressing the *Confirm (33)* button.

### Unit

Select the *Unit* menu item in the menu by pressing the *Minus (32)* button. Then press the *Confirm (33)* button. Here you can select the unit of the display; metric and imperial.

You can set your selection by pressing the *Confirm (33)* button. If you only want to change one unit, use the *Minus (32)* button to select the desired unit and then press the *Confirm (33)* button.

Basic 229V
<b>Machine Settings</b>
< Settings
Data & Time >
<b>Unit &gt;</b>
LCD Contrast [%] 89
LCD Backlight wh [%] 90
LCD Backlight rd [%] 90
Key Backlight <input type="checkbox"/>

Basic 230V
<b>Unit</b>
< Machine Settings
<b>Global Unit imperial</b>
Unit Speed imperial
Unit Heat imperial

Basic 230V
<b>Unit</b>
< Machine Settings
<b>Global Unit metric</b>
Unit Speed metric
Unit Heat metric

### LCD Contrast

Basic 229V
<b>Machine Settings</b>
< Settings
Data & Time >
Unit >
<b>LCD Contrast [%] 89</b>
LCD Backlight wh [%] 90
LCD Backlight rd [%] 90
Key Backlight <input type="checkbox"/>

Basic 230V
<b>Machine Settings</b>
< Settings
Data & Time >
Unit >
LCD Contrast [%] <b>100</b>
LCD Backlight wh [%] 90
LCD Backlight rd [%] 90
Key Backlight <input type="checkbox"/>

Select the *LCD Contrast* menu item in the menu by pressing the *Minus (32)* button. Then press the *Confirm (33)* button.

Use the *Minus/Plus (32)* button to set the contrast. Pressing the *Confirm (33)* button accepts the set value.

## LCD Backlight

Basic 230V
<b>Machine Settings</b>
< Settings
Data & Time >
Unit >
LCD Contrast [%] 100
LCD Backlight wh [%] 90
LCD Backlight rd [%] 90
Key Backlight <input type="checkbox"/>

Basic 230V
<b>Machine Settings</b>
< Settings
Data & Time >
Unit >
LCD Contrast [%] 100
LCD Backlight wh [%] 100
LCD Backlight rd [%] 90
Key Backlight <input type="checkbox"/>

Select the *LCD Backlight wh* or *LCD Backlight rd* menu item in the menu by pressing the *Minus (32)* button. Then press the *Confirm (33)* button. Use the *Minus/Plus (32)* button to set the intensity of the white backlight or red backlight. Pressing the *Confirm (33)* button accepts the set value.

## Backlight button

Basic 229V
<b>Machine Settings</b>
Data & Time >
Unit >
LCD Contrast [%] 100
LCD Backlight wh [%] 100
LCD Backlight rd [%] 100
Key Backlight <input type="checkbox"/>
Reset to defaults

Basic 229V
<b>Machine Settings</b>
Data & Time >
Unit >
LCD Contrast [%] 100
LCD Backlight wh [%] 100
LCD Backlight rd [%] 100
Key Backlight <input checked="" type="checkbox"/>
Reset to defaults

Select in the menu by pressing the button *Minus (32)* the menu item *Key Backlight*. Pressing the *Confirm (33)* button enables you to turn the illumination of the keyboard on or off.

## Reset to defaults

Select the *Reset to defaults* menu item in the menu by pressing the *Minus (32)* button. Press the *Confirm (33)* button and then the *Plus (32)* button. If you now press the *Confirm (33)* button, all settings are reset to the factory settings.

Basic 229V
<b>Machine Settings</b>
Data & Time >
Unit >
LCD Contrast [%] 89
LCD Backlight wh [%] 90
LCD Backlight rd [%] 90
Key Backlight <input type="checkbox"/>
Reset to defaults

Basic 229V
<b>Machine Settings</b>
Data & Time >
Unit >
LCD Contrast [%] 100
LCD Backlight wh [%] 100
LCD Backlight rd [%] 100
Key Backlight <input checked="" type="checkbox"/>
Reset to defaults <input checked="" type="checkbox"/>

Basic 227V
<b>Machine Settings</b>
Data & Time >
Unit >
LCD Contrast [%] 100
LCD Backlight wh [%] 100
LCD Backlight rd [%] 100
Key Backlight <input checked="" type="checkbox"/>
Reset to defaults <input checked="" type="checkbox"/>

## 10.10 Info Mode

Basic 222V		}}
		460
		100 %
	Speed 257cm/min	
	Heat 56% 498 °C	
	Amb. 26 °C	
	Mains 222V	

Switched off at the factory

If Info Mode is activated, additional information is displayed at the work level.

The following information is displayed:

- Speed in a resolution of 1 cm/min
- Capacity utilization of the heating output in percent as well as the temperature in 1°C resolution
- Ambient temperature
- Supply voltage in 1V resolution

Basic 231V	
<b>Settings</b>	
Eco Mode	>
LQS	>
Advanced Mode	<input type="checkbox"/>
WLAN	>
Machine Settings	>
<b>Info Mode</b>	<input type="checkbox"/>
Duty Info	>

Basic 232V	
<b>Settings</b>	
Eco Mode	>
LQS	>
Advanced Mode	<input type="checkbox"/>
WLAN	>
Machine Settings	>
<b>Info Mode</b>	<input checked="" type="checkbox"/>
Duty Info	>

To activate Info Mode, proceed as follows:

Select the Info Mode menu item in the menu by pressing the *Minus (32)* button. The Info Mode is activated by pressing the *Confirm (33)* button.

## 10.11 Duty information

Basic 231V	
<b>Settings</b>	
LQS	>
Advanced Mode	<input type="checkbox"/>
WLAN	>
Machine Settings	>
Info Mode	<input type="checkbox"/>
<b>Duty Info</b>	>
General Info	>

Basic 229V	
<b>Duty Info</b>	
< Settings	
<b>Hours Machine [h]</b>	4
Hours Drive [min]	15
Hours Blower [h]	2
Trip Distance [km]	0.04
Total Distance [km]	0.04

Select the Duty Info menu item in the menu by pressing the *Minus (32)* button. Then press the *Confirm (33)* button.

The runtimes of the machine, the drive and the blower are displayed. In the two lines below, you can see the distances traveled as a day counter and as total run time. The day counter can be deleted.

To delete the day counter, select the menu item Trip Distance by pressing the *Minus (32)* button. Press the *Confirm (33)* button and then the *Plus (32)* button. Pressing the *Confirm (33)* button again deletes the day counter.

Basic 229V	
<b>Duty Info</b>	
< Settings	
Hours Machine [h]	4
Hours Drive [min]	15
Hours Blower [h]	2
<b>Trip Distance [km]</b>	0.04
Total Distance [km]	0.04

Basic 229V	
<b>Duty Info</b>	
< Settings	
Hours Machine [h]	4
Hours Drive [min]	15
Hours Blower [h]	2
Trip Distance [km]	
Total Distance [km]	0.04

Basic 229V	
<b>Duty Info</b>	
< Settings	
Hours Machine [h]	4
Hours Drive [min]	15
Hours Blower [h]	2
Trip Distance [km]	
Total Distance [km]	0.04

Basic 228V	
<b>Duty Info</b>	
< Settings	
Hours Machine [h]	4
Hours Drive [min]	15
Hours Blower [h]	2
<b>Trip Distance [km]</b>	0.00
Total Distance [km]	0.04

## 10.12 General information

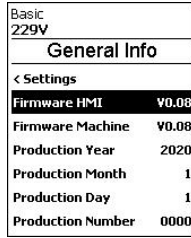

Select the *General Info* menu item in the menu by pressing the *Minus (32)* button. Then press the *Confirm (33)* button.

The following information is displayed:

- Software version HMI and PCU
- Production date of the machine
- Serial number

## 11. UNIROOT 700 Warning and error messages

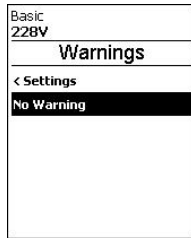

In the menu, select the menu item *Warnings* by pressing the *Minus (32)* button. Then press the *Confirm (33)* button.



All warnings are now displayed.

**If there is a warning pending, you can still continue to work largely without restrictions.**

In contrast to the warning message, it is **not possible to continue working once an error message has appeared**. The heating is switched off automatically and the drive is blocked. The corresponding error code is immediately displayed in the working display (41).

Concrete information regarding the type of error or the warning can be called up at any time, including via the menu *Settings* under *Show Warnings*.

Message type	Display	Error code	Description and measures
Warning		---	<p>Example warning symbol in the status display (33).</p> <p>Supply voltage is too high At the same time, the red backlight of the LCD module is switched on alternately</p>
Error		0008	<p>Error symbol and text of note (Error No. 0008/Excessive temperature) in the work display.</p> <p>Solution: Let the device cool down</p>

Error	<div style="border: 1px solid black; padding: 5px;"> <p>Basic <b>231V</b></p>  <p><b>Error No.0020</b></p> </div>	0020	<p>Error symbol and text of note (Error No. 0020/Heating element defective) in the work display. Solution: Replace the heating element</p>
Error (with address of Leister Service Center as needed)*	<div style="border: 1px solid black; padding: 5px;"> <p>Basic <b>162V</b></p>  <p><b>Error No.0002</b></p> </div>	0002	Undervoltage/overvoltage
		0004	Hardware error
		0008	Thermoelement is defective
		0100	Blower is faulty
		0200	Communication module error
	<div style="border: 1px solid black; padding: 5px;"> <p>Basic <b>232V</b></p>  <p><b>Error No.0100</b> Contact your service center <a href="http://www.leister.com">www.leister.com</a></p> </div>	0400	Drive error
<b>*Contact Leister Service Center</b>			

## 12. FAQ, causes and actions UNIROOF 700



### The machine switches on automatically after the blowers have been switched on:

- If the air temperature is higher than 100°C when the device is switched on – which can occur, for example, if the device is disconnected from the power supply without cooling down – the device automatically switches to cool-down mode. The cool-down process is finished when the air temperature is less than 100°C for 2 minutes.

### Machine switches off automatically:

- In Standby operation, the heating is switched off automatically after the time elapses that the user has stored (see also  Standby mode [10.5]).



### Welding result of deficient quality:

- Check drive speed, welding temperature and air volume.
- Clean the **welding nozzle (9)** with a wire brush (see  Maintenance [7.4])
- **Welding nozzle (9)** set incorrectly (see  Setting the welding nozzles [5.1]).

### If the set welding temperature still has not been reached after 5 minutes:

- Check the supply voltage
- Reduce the air volume

### Device does not move forward in a straight line:

- **Align the track guide roller (16)** so that it is parallel and linear to the **drive/pressure roller (8)** (see  welding sequence [7.2]).
- Adjust the **transport roller (13)** to the movable **transport axle (14)** (see  Adjust the movable transportation axle [patent EP3 028 836 pending] [5.4])

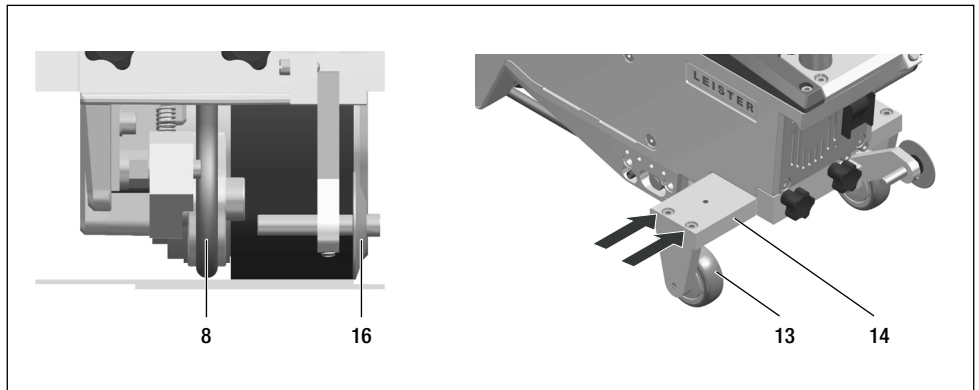

## 13. Operation of your UNIROOF 300

### 13.1 Starting the device

- Once you have prepared the working area and the hot air welder in accordance with the description, connect the hot air welder to the supply voltage.
- Use the **main switch (19)** to switch the hot-air welder on.

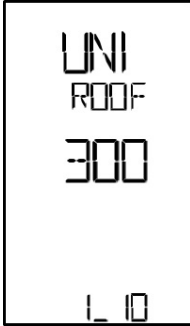

After connection, the start screen appears briefly on the display of the **operating unit (2)** with the **version number** of the current software release and the device designation.

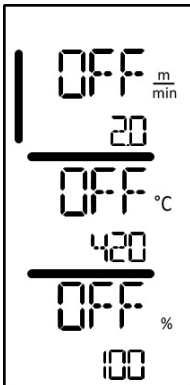

If the device was allowed to cool down beforehand, this will be followed by a static display of the setpoints for the most recently set welding parameters.

**At this stage, the heating, blower and drive are switched off.**

Now switch the heating on with the *Heating On/Off* button.

### 13.2 Welding sequence

#### Preparing for welding

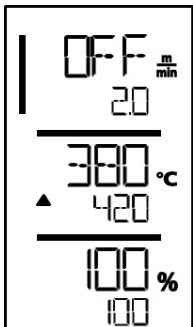

As soon as you have switched on the heating, you will see a dynamic display of the current air temperature (setpoint and actual value). All welding parameters (welding speed, temperature and air volume) can be set.

- Make sure that the welding temperature has been reached before commencing work (LED stops flashing). The heat-up time is 3–5 minutes.
- Now carry out test welds in accordance with the welding instructions of the material manufacturer and/or national standards or regulations and inspect the results. Adjust the welding profile as required.

### Start welding

- Pull the **hot-air blower lock lever (15)**, lower the **hot-air blower (10)** and guide the **welding nozzle (9)** between the overlapping sheets up to the stop.
- The drive motor starts automatically as soon as the **hot-air blower (10)** is engaged.

### Guiding the device during the welding process

- Guide the hot-air welder by the **guide bar (22, 24)** or by the **carrying handle (5)** along the overlap and also observe the position of the **track guide roller (16) at all times**.
- Avoid applying pressure to the **guide bar (22, 24)** during the welding process, as doing so could lead to welding faults.

### 13.3 Finishing welding

- After finishing welding, pull the **hot-air blowers lock (15)**, extend the **hot-air blowers (10)** up to the stop and swivel them upwards until they engage.
- Then swivel the **track guide roller (16)** upwards.

### 13.4 Switching off the device / Maintenance

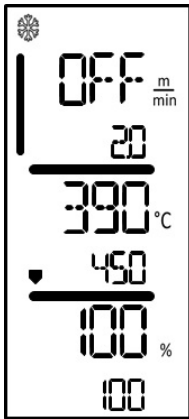

- Use the *heating (31)* button to switch off the heating so that the **welding nozzle (9)** cools down.

The blower switches off automatically after approx. 6 minutes.



Wait until the device has cooled down.

Now switch off the device with the **main switch (19)** and disconnect the **power cord (1)** from the electrical network.

Check the **power cord (1)** and plug for electrical and/or mechanical damage.

Use a wire brush to clean the **welding nozzle (9)**.



## 14. Quick Reference Guide UNIROOF 300

### 14.1 Switching on/Starting

1. Make sure that the **main switch (19)** is switched off and the **hot-air blower (10)** is in parking position. Connect the supply voltage plug.
2. Switch on the **main switch (19)**.
3. **Switch on the heating with the Heating On/Off (31)** button; wait 3–5 minutes until the desired temperature is reached.
4. Swivel the **hot-air blower (10)** downwards (**machine starts automatically**).



### 14.2 Switching off

1. Swivel the **hot-air blowers (10)** upwards (**stops the drive motor**).
2. **Switch off the heating with the Heating On/Off (31)** button.
3. Wait for the end of the cool-down process (approx. 5 minutes).
4. **Switch off the main switch (19)**.
5. Pull out supply voltage plug



**UNIROOF 300/700**  
Quick Guide

User Manual:  [leister.com/uniroof-700](http://leister.com/uniroof-700)



Download myLeister App 

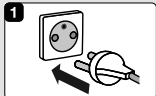

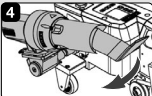





- 1 
- 2 
- 3 
- 4 



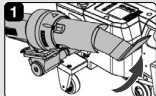

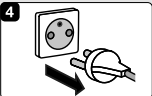
- 1 
- 3 



- 1 
- 2 
- 3 
- 4 

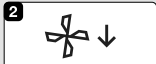

- 2 
- 4 

QG UNIROOF 300/700 / Art. 169.182 / 09.2021





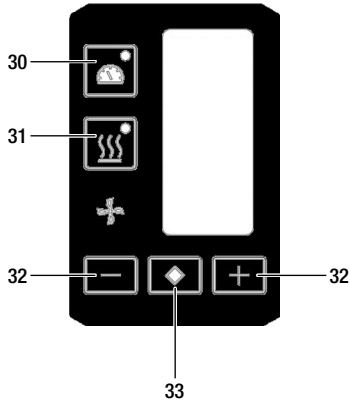

## 15. The UNIROOF 300 operating unit

### 15.1 Function buttons



- 30. Button *Drive On/Off*
- 31. Button *Heating On/Off*
- 32. Buttons *Plus/Minus*
- 33. Button *Confirm*

### Function buttons

Symbol	Name	Function
	Button <i>Motor On/Off (30)</i>	Switches drive on and off
	Button <i>Heating On/Off (31)</i>	Switches heating on and off
	Blower symbol	No function
 	Buttons <i>Plus/Minus (32)</i>	Setting the required setpoint in increments of 0.1m/min, 10°C or 5%
	Button <i>Confirm (33)</i>	Switches between the setpoint values to be set

## 15.2 Display

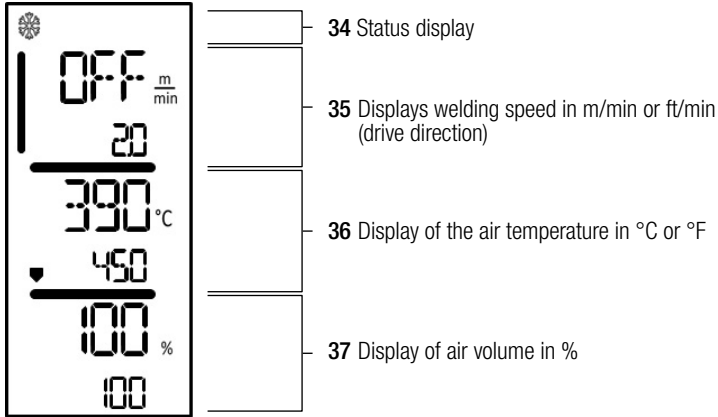





During operation, the setpoints of the welding parameters (drive in m/min or ft/min, temperature in degrees Celsius or Fahrenheit), air volume in percent and, if applicable, information notes are displayed.

Use the *Confirm* (33) button to switch between the welding parameters and adjust the values individually with the *Minus/Plus arrow* (32) buttons.

## 15.3 Display symbols of the status display (Display 34)

### Status display

	Symbol for Cool-down mode
	Symbol for <b>warning note, warning message or error message:</b> Allow the device to cool down. (see also  Warning notes / Symbols for warning and error messages [17])
	Reference to service. <ul style="list-style-type: none"> <li>• Symbol for hardware error message.</li> </ul> The device is no longer ready for operation. Contact an authorized Leister Service Center. (Note the respective error code in Section  Warning and Error Messages [17]).

## 15.4 Display symbols for the welding speed (Display 35)



### Actual and setpoint value of the welding speed

The arrow in the display for the welding speed indicates the drive direction.

## 15.5 Display symbols for the welding temperature (Display 36)



- **Welding temperature too low, the heating process up arrow** indicates that the desired **higher temperature** has not yet been reached. The flashing number designates the currently achieved actual value (430); the value below (450) shows the setpoint of the individual setting.



- **Welding temperature too high, cool-down process. Down arrow** shows that the desired **lower temperature** has not yet been reached. The flashing value designates the currently achieved actual value (470); the value below (450) shows the setpoint of the individual setting.

## 15.6 Display symbols for the air volume (Display 37)



### Actual and setpoint value of the air volume

## 15.7 Status LED display

### Heating

The LED on the *Heating On/Off (31)* button displays the condition of the heating.

LED status <i>Heating On/Off (31)</i>	Condition
LED off	Heating is switched off.
LED flashes green	Heating is switched on. Temperature is outside the tolerance.
LED continuously green	Heating is switched on. Temperature is inside the tolerance.

### drive

The LED on the *Drive On/Off (30)* button displays the condition of the drive.

LED status <i>Drive On/Off (30)</i>	Condition
LED off	Drive is switched off
LED continuously green	Drive is switched on

### Heating and drive

If the two LEDs for the *Heating On/Off (31)* button and the *Drive On/Off (30)* button flash simultaneously, an error is present (see Section  Error message [17]).

## 16. Settings and functions of the UNIROOF 300 software

### 16.1 Setting the parameter units

The units for the welding speed and for the temperature can be adjusted.

Temperature:      °C      or      °F

Speed:              $\frac{\text{m}}{\text{min}}$       or       $\frac{\text{ft}}{\text{min}}$

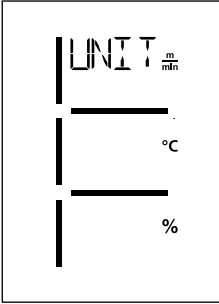

- Hold down the *Drive On/Off (30)* and *Heating On/Off (31)* buttons and connect the power cord to the power supply. The display now shows UNIT.
- Press the *Confirm (33)* button to confirm and use the *Plus/Minus (32)* buttons to set the desired units.
- Press the *Confirm (33)* button to confirm and use the *Plus/Minus (32)* buttons to select SAVE. Press the *Confirm (33)* button to confirm; the units are then saved.

The device then restarts automatically.

### 16.2 Setting the welding parameters

You can regulate the setpoints of the three welding parameters individually, even during operation.

During operation, the selected range automatically switches back to the row **welding speed (35)** after 5 seconds.

Proceed as follows:

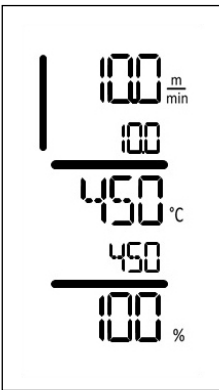

#### Select:

Select the desired setpoint for drive, temperature or air with the *Confirm (33)* button.

#### Representation:

The selected area is indicated by a bar at the side

#### Setting:

Use the *Plus/Minus buttons (32)* to adjust the selected setpoint to match your requirements.

### 16.3 Cool-down mode

The heating is switched off during the cool down process. The setpoints cannot be changed during the cool down process.

If the air temperature is more than 60°C when the device is switched on, the device switches to cool-down mode automatically.

The cool-down process is finished when the air temperature is less than 100°C for 2 minutes.

If the heating is to be switched on again, you must press the *Heating On/Off (31)* button.

### 16.4 Monitoring welding parameters for runtime

Welding speed, air temperature and air volume are monitored continuously.

If an actual value deviates from the setpoint according to the individual settings, this is indicated in the working display (see Section  Display symbols of welding temperature [15.5]).

## 17. Warning and error messages UNIROOF 300

Error messages are shown on the display of the **operating unit (2)**.

**If an error message appears, you cannot continue working.**

The heating is switched off automatically and the drive is blocked. The corresponding error codes are displayed immediately on the display of the **operating unit (2)**. The first four digits indicate the error group. The second four digits indicate the detailed error.

Example:

Error

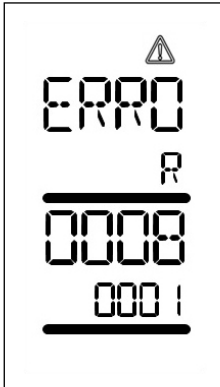

Warning:

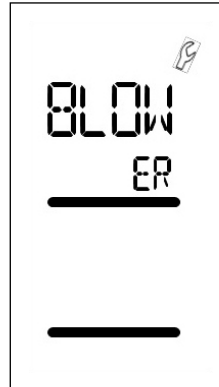

Error group	Description	Measures
0001	Electronics temperature measurement	Temperature > 90°C. Allow the device to cool down
0004	Supply voltage	Connect the device to a different power socket. If the error is still displayed, contact the Leister Service Center.
0008	Thermoelement/ heating element	Contact Leister Service Center
0100	Blower motor	Contact Leister Service Center
0400	Drive motor	Contact Leister Service Center
BLOWER	Carbon brushes for blower motor	Appears after 1400 operating hours. The carbon brushes of the blower motor must be replaced.

## 18. FAQ, causes and actions UNIROOF 300

### Welding result of deficient quality:

- Check drive speed, welding temperature and air volume.
- **Clean the welding nozzle (9)** with a wire brush (see [Maintenance](#) [13.4]).
- **Welding nozzle (9)** incorrectly set (see [Adjusting welding nozzles](#) [5.1]).

### If the set welding temperature has still not been reached after 5 minutes:

- Check supply voltage.
- Reduce air volume.

### Device does not move forward in a straight line:

- Align the **track guide roller (16)** so that it is parallel and linear to the **drive/pressure roller (8)** (see [Welding sequence](#) [13.2]).
- Adjust the **transport roller (13)** on the movable **transport axle (12)** (see [Adjusting the movable transport axle](#) [Patent EP3 028 836 issued] [5.4]).

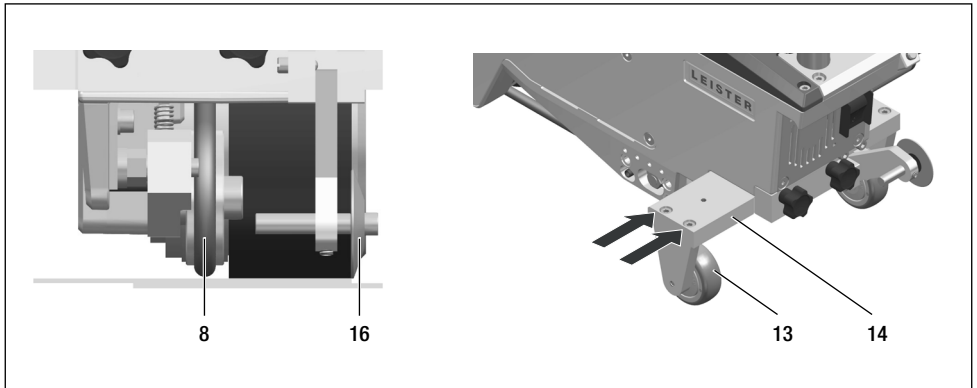



## 19. Accessories

Only use original Leister spare parts and accessories; otherwise, any warranty or guarantee claims will be invalidated.

You can find more information at [www.leister.com](http://www.leister.com).

## 20. Service and repair

Repairs shall be performed exclusively by authorized Leister Service Centers. Leister Service Centers guarantee a professional and reliable repair service within 24 hours with original spare parts in accordance with circuit diagrams and spare parts lists. You will find the address of your authorized Service Center on the last page of these operating instructions.

You can find more information at [www.leister.com](http://www.leister.com).

## 21. Training

Leister Technologies AG and its authorized Service Centers offer welding courses and introductory training classes.

You can find more information at [www.leister.com](http://www.leister.com).

## 22. Warranty

- The guarantee or warranty rights granted for this device by the direct distribution partner/salesperson apply from the date of purchase.
- In the event of a guarantee or warranty claim (verification by invoice or delivery note), manufacturing or processing errors will be rectified by the sales partner through replacement delivery or repair.
- Other guarantee or warranty claims are excluded within the framework of mandatory law.
- Damage resulting from natural wear, overload, or improper handling is excluded from the warranty.
- Heating elements are excluded from warranty obligations or guarantees.
- Guarantee or warranty claims cannot be asserted for devices that have been converted or changed by the purchaser or for which non-original Leister spare parts have been used.

## 23. Declaration of Conformity

### EU Declaration of Conformity

**Leister Technologies AG, Galileo-Strasse 10, 6056 Kaegiswil, Switzerland** confirms that this product fulfills the requirements of the following EU Guidelines in the models that we have made available for purchase.

Directives: 2006/42/EC, 2014/30/EU, 2014/53/EU, 2011/65/EU

Harmonized standards: EN ISO 12100, EN 60335-1, EN 60335-2-45, EN 55014-1, EN 55014-2, EN 61000-3-2, EN 61000-3-3, EN 61000-3-11, EN 61000-6-2, ETSI EN 300 328, EN IEC 63000

Name of authorized representative for documentation: Thomas Schäfer, Manager Product Conformity

Kaegiswil, 04/14/2021

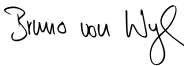

Bruno von Wyl, CTO



Christoph Baumgartner, GM

---

### UK Declaration of Conformity

**Leister Technologies AG, Galileo-Strasse 10, 6056 Kaegiswil, Switzerland** confirms that these products, in the versions as brought into circulation through us, fulfil the requirements of the following UK Statutory Instruments.

UK Statutory

Instruments: 2008 No. 1597, 2016 No. 1091, 2017 No. 1206, 2012 No. 3032

Designated BS EN ISO 12100, BS EN 60335-1, BS EN 60335-2-45, BS EN 55014-1, BS EN 55014-2,

Standards: BS EN 61000-3-2, BS EN 61000-3-3, BS EN 61000-3-11, BS EN 61000-6-2, ETSI EN 300 328, BS EN IEC 63000

Name of authorized representative for documentation: Thomas Schäfer, Manager Product Conformity

Kaegiswil, 03/31/2021

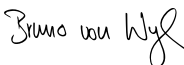

Bruno von Wyl, CTO



Christoph Baumgartner, GM

## 24. Disposal



Do not dispose of electrical tools in household waste.

Electrical equipment, accessories and packaging should be recycled in an environmentally friendly manner.



Your authorised Service Centre is:

A large, empty rectangular box with a thin black border, intended for the user to write the name and address of their authorized service center.

↳ Sales and service center

Leister Technologies AG  
Galileo-Strasse 10  
CH-6056 Kaegiswil/Switzerland  
Tel. +41 41 662 74 74  
Fax +41 41 662 74 16  
[www.leister.com](http://www.leister.com)  
[sales@leister.com](mailto:sales@leister.com)